

# Washroom Accessories



# 6 DESIGN COLLECTIONS 20 CURATED CATEGORIES



## PARTITIONS

A wide range of partitions designed to enhance any interior.



## WASHROOM ACCESSORIES

The most comprehensive selection of washroom accessories available anywhere.



**Navigate the catalog by**

**Collection:**  
design coordinated products,  
Pages 4 & 5.

**Product Category:**  
e.g. Paper Towel Dispensers,  
Pages 6 & 7.

**Index:**  
Model No. or Category,  
Pages 160-163.



**LOCKERS + BENCHES**

Available to be built in any configuration matrix with multiple base options, tiers, and styles to choose from.



**VISUAL DISPLAY PRODUCTS**

Through constant research, innovation, and development, we design and manufacture high quality visual display products that are easy to install and require little maintenance.

# 6 COLLECTIONS / 3 TIERS

Good



Better



Best



# Simplicity™

The Beautiful Simple



P.16

# Roval™

Overarching The Form



P.24

# Traditional™

The Original



P.32



# Matte Black

Trending Crossover

P.42

## WASHROOM ACCESSORIES



## TOILET ACCESSORIES



## ADDITIONAL ACCESSORIES

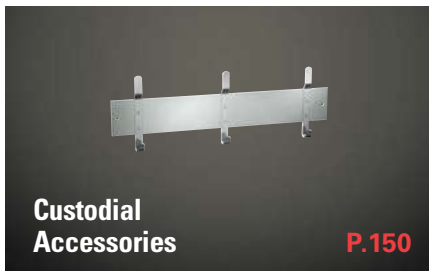
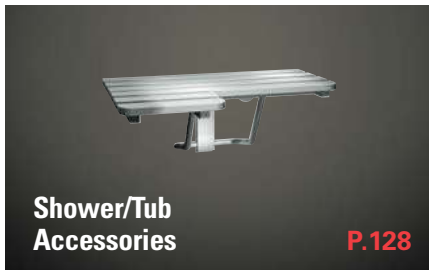



## PIATTO™ COLLECTION DETAILS

COMPLETELY  
**RECESSED**

**UNIQUE DESIGN**

100% coplanar with the wall  
— zero protrusion.

**PHENOLIC**  
DOORS

**ELEVATED STYLE—  
A NEW CHOICE**

Phenolic doors in matte  
black or white.

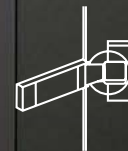

**CONCEALED LOCKS,  
NO VISIBLE HARDWARE**

Fully concealed hardware,  
3D-adjustable hinges.

# PIATTO™ COLLECTION

## The Flush Finesse

Its industry-wide unique design makes Piatto completely flush with the wall, as its silent doors do not have any protrusion.



### THREE-WAY ADJUSTABLE HINGE

An innovative hinge technology allows cabinet and doors to be completely recessed, with no protrusions from the plane of the wall surface. Silent doors can be adjusted in the field.

- Phenolic Doors
- Completely Recessed Mounting
- Concealed Internal Spring-Loaded Latch
- No Visible Hardware



**6467**  
**PIATTO™ PAPER TOWEL DISPENSER AND WASTE RECEPTACLE**

---

**800** MULTI-FOLD  
 OR 600 C-FOLD  
 PAPER TOWELS

**4.2 gal.**  
 WASTE CAPACITY  
 (16 L)

**MANUAL**  
 DISPENSING

**Model Options:**  
**6467-00** White Door.  
**6467-41** Matte Black Door.

**Unit Size:**  
 13" x 55" x 4<sup>9</sup>/<sub>16</sub>"  
 (330 x 1397 x 116 mm)

**Finished Wall Opening\*:**  
 13<sup>7</sup>/<sub>16</sub>" x 55<sup>1</sup>/<sub>16</sub>" x 4<sup>11</sup>/<sub>16</sub>"  
 (332 x 1399 x 119 mm)



**64623**  
**PIATTO™ PAPER TOWEL DISPENSER AND WASTE RECEPTACLE**

---

**475** MULTI-FOLD  
 OR 350 C-FOLD  
 PAPER TOWELS

**2.2 gal.**  
 WASTE CAPACITY  
 (8.4 L)

**MANUAL**  
 DISPENSING

**Model Options:**  
**64623-00** White Door.  
**64623-41** Matte Black Door.

**Unit Size:**  
 14<sup>1</sup>/<sub>4</sub>" x 28" x 4<sup>9</sup>/<sub>16</sub>"  
 (362 x 711 x 116 mm)

**Finished Wall Opening\*:**  
 14<sup>5</sup>/<sub>16</sub>" x 28<sup>7</sup>/<sub>16</sub>" x 4<sup>11</sup>/<sub>16</sub>"  
 (364 x 713 x 119 mm)



**6457**  
**PIATTO™ PAPER TOWEL DISPENSER**

---

**475** MULTI-FOLD  
 OR 350 C-FOLD  
 PAPER TOWELS

**MANUAL**  
 DISPENSING

**Model Options:**  
**6457-00** White Door.  
**6457-41** Matte Black Door.

**Unit Size:**  
 12<sup>3</sup>/<sub>4</sub>" x 17<sup>1</sup>/<sub>4</sub>" x 4<sup>9</sup>/<sub>16</sub>"  
 (324 x 438 x 116 mm)

**Finished Wall Opening\*:**  
 12<sup>13</sup>/<sub>16</sub>" x 17<sup>5</sup>/<sub>16</sub>" x 4<sup>3</sup>/<sub>4</sub>"  
 (325 x 440 x 121 mm)



**6474-00**  
**PIATTO™ WASTE RECEPTACLE**

---

**12 gal.**  
 WASTE CAPACITY  
 (46 L)

**Model Options:**  
**6474-00** White Door.  
**6474-41** Matte Black Door.

**Unit Size:**  
 17<sup>1</sup>/<sub>4</sub>" x 40" x 6<sup>9</sup>/<sub>16</sub>"  
 (438 x 1016 x 166 mm)

**Finished Wall Opening\*:**  
 17<sup>5</sup>/<sub>16</sub>" x 40<sup>1</sup>/<sub>16</sub>" x 6<sup>11</sup>/<sub>16</sub>"  
 (440 x 1018 x 170 mm)

ALL STAINLESS STEEL IS TYPE 304 WITH SATIN FINISH, UNLESS OTHERWISE NOTED.

\*All Piatto™ models require finished wall openings for installation. The edges of the finished wall opening are meant to be visible after installation, hence edges must be flat, square, straight, and plumb—no rough or unsightly edges.



**6462**  
**PIATTO™ PAPER TOWEL DISPENSER  
 AND WASTE RECEPTACLE**

**800** MULTI-FOLD  
 OR 600 C-FOLD  
 PAPER TOWELS

**9 gal.**  
 WASTE CAPACITY  
 (34 L)

**MANUAL**  
 DISPENSING

**Model Options:**  
**6462-00** White Door.  
**6462-41** Matte Black Door.

**Unit Size:**  
 17¼" x 54" x 6⅞"  
 (438 x 1372 x 166 mm)

**Finished Wall Opening\*:**  
 17⅝" x 54⅞" x 6⅞"  
 (440 x 1373 x 170 mm)



**64696A/AC**  
**PIATTO™ AUTOMATIC ROLL PAPER TOWEL  
 DISPENSER AND WASTE RECEPTACLE**

**UP TO 800 ft.**  
 (244 M) LONG ROLL  
 TOWEL CAPACITY

**9.9 gal.**  
 WASTE CAPACITY  
 (37.3 L)

**NO-TOUCH**  
 DISPENSING

**Model Options:**  
**64696A-00** White Door.  
**64696A-41** Matte Black Door.  
**64696AC-00** White Door.  
**64696AC-41** Matte Black Door.

**Unit Size:**  
 16⅞" x 41¼" x 9⅞"  
 (408 x 1048 x 246 mm)

**Finished Wall Opening\*:**  
 16⅞" x 41⅝" x 10"  
 (410 x 1049 x 254 mm)



**645210A/AC**  
**PIATTO™ AUTOMATIC ROLL PAPER TOWEL DISPENSER**

**UP TO 800 ft.**  
 (244 M) LONG ROLL  
 TOWEL CAPACITY

**NO-TOUCH**  
 DISPENSING

**Model Options:**  
**645210A-00** White Door.  
**645210A-41** Matte Black Door.  
**645210AC-00** White Door.  
**645210AC-41** Matte Black Door.

**Unit Size:**  
 16⅞" x 28" x 9⅞"  
 (408 x 711 x 248 mm)

**Finished Wall Opening\*:**  
 16⅞" x 28⅞" x 10"  
 (410 x 713 x 254 mm)



**64672-1**  
**PIATTO™ COMPLETELY RECESSED 3-IN-1 PAPER TOWEL  
 DISPENSER, HIGH-SPEED HAND DRYER, AND  
 WASTE RECEPTACLE**

**500** MULTI-FOLD  
 OR 400 C-FOLD  
 PAPER TOWELS

**6.8 gal.**  
 WASTE CAPACITY  
 (26 L)

**<15 sec.**  
 DRYING TIME

**MANUAL**  
 DISPENSING

**Model Options:**  
**64672-1-00** White Door.  
**64672-1-41** Matte Black Door.

**Unit Size:**  
 15⅝" x 55⅝" x 7⅞"  
 (391 x 1407 x 191 mm)

**Finished Wall Opening\*:**  
 15⅞" x 55⅞" x 7⅞"  
 (392 x 1408 x 194 mm)

**Noise Level:** 68.9-74.3 dBA



## VELARE™ COLLECTION DETAILS

### ARTFULLY CONCEALED

#### ARTFULLY CONCEALED

Consumables are concealed behind the mirror.

### SOAP



#### CONCEALED SOAP DISPENSER

High-capacity foam or liquid soap dispenser makes Velare™ ideal for high-frequency-use restrooms.

### TOWEL



#### PAPER TOWEL OPTION

Velare™ provides paper towels as an option for drying hands. 500 towel capacity.

### AIR



#### HAND DRYER OPTION

Optional high-speed, low-decibel hand dryer is equipped with a HEPA filter.

# VELARE™ COLLECTION

## The Concealed Elegance

An elegant solution for a clean and sleek washroom appearance, where humble design meets comfort and function.

**ALL-IN-ONE Cabinet houses a**  
– paper towel dispenser or high-speed hand dryer and  
– a liquid soap- or foam-soap dispenser  
**Collection includes mirror fillers for design flexibility.**

Backlit icons etched into the mirror facilitate an intuitive user experience.





**0661-1**  
**VELARE™ STAINLESS STEEL CABINET WITH**  
**FRAMELESS MIRROR, LIQUID SOAP DISPENSER,**  
**AND HIGH-SPEED HAND DRYER (110-120 V)**



AIR

**68-73.8**  
 NOISE LEVEL



LIQUID SOAP

**Model Option:**  
**0661-2 Velare™ Stainless Steel Cabinet with Liquid Soap**  
**and Hand Dryer (208-240 V).**

**Overall Dimensions:**  
 23<sup>3</sup>/<sub>16</sub>" x 35<sup>7</sup>/<sub>16</sub>" x 7<sup>9</sup>/<sub>16</sub>"  
 (600 x 900 x 192 mm)



**0661-T**  
**VELARE™ STAINLESS STEEL CABINET WITH**  
**FRAMELESS MIRROR, LIQUID SOAP DISPENSER,**  
**AND PAPER TOWEL DISPENSER**

**500**

PAPER TOWELS



LIQUID SOAP

**.4 GAL. (1.5 L).**  
 CAPACITY

**Overall Dimensions:**  
 23<sup>3</sup>/<sub>16</sub>" x 35<sup>7</sup>/<sub>16</sub>" x 7<sup>9</sup>/<sub>16</sub>"  
 (600 x 900 x 192 mm)



**0661-FM-14**  
**VELARE™ STAINLESS STEEL FRAMELESS**  
**MIRROR FILLER MODULE**

**SURFACE**  
 MOUNTED

**Overall Dimensions:**  
 14<sup>3</sup>/<sub>4</sub>" x 35<sup>7</sup>/<sub>16</sub>" x 7<sup>9</sup>/<sub>16</sub>"  
 (375 x 900 x 192 mm)



**0661-FM-23**  
**VELARE™ STAINLESS STEEL FRAMELESS**  
**MIRROR FILLER MODULE**

**SURFACE**  
 MOUNTED

**Overall Dimensions:**  
 23<sup>1</sup>/<sub>4</sub>" x 35<sup>7</sup>/<sub>16</sub>" x 7<sup>9</sup>/<sub>16</sub>"  
 (591 x 900 x 192 mm)



**0663-1**  
**VELARE™ STAINLESS STEEL CABINET WITH FRAMELESS MIRROR, FOAM SOAP DISPENSER, AND HIGH-SPEED HAND DRYER (110-120 V)**

 AIR    
  **68-73.8** dBA NOISE LEVEL    
  FOAM SOAP

**Model Option:**  
**0663-2** Velare™ Stainless Steel Cabinet with Foam Soap and Hand Dryer (208-240 V).

**Overall Dimensions:**  
 23<sup>5</sup>/<sub>16</sub>" x 35<sup>7</sup>/<sub>16</sub>" x 7<sup>9</sup>/<sub>16</sub>"  
 (600 x 900 x 192 mm)



**0663-T**  
**VELARE™ STAINLESS STEEL CABINET WITH FRAMELESS MIRROR, FOAM SOAP DISPENSER, AND PAPER TOWEL DISPENSER**

 **500** PAPER TOWELS    
  FOAM SOAP    
  **.4 GAL. (1.5L).** CAPACITY

**Overall Dimensions:**  
 23<sup>5</sup>/<sub>16</sub>" x 35<sup>7</sup>/<sub>16</sub>" x 7<sup>9</sup>/<sub>16</sub>"  
 (600 x 900 x 192 mm)

Velare™ minimizes the hazards of water spilling on the floor after the handwashing process by housing drying and soap components directly above the sink.

This marriage of elegance and functionality makes Velare™ ideal for a wide range of PREMIUM building types, such as sophisticated corporate headquarters.





## SIMPLICITY™ COLLECTION DETAILS



### **SIMPLY CONCEALED**

Presenting itself in a sleek and streamlined appearance, the 18-gauge stainless steel door is attached with concealed  $\frac{3}{16}$ " (5 mm) diameter full-length piano hinges.



### **SAFE, EASY DISPENSING**

Towel dispensers have hemmed opening for safe, easy dispensing, minimizing waste, and ensuring hygienic use.



### **EASY LIFT OUT RECEPTACLE**

Fully removable stainless steel waste cans allow contents to be easily discarded for efficient ongoing maintenance and cleanliness.



# **SIMPLICITY™** COLLECTION

## **The Beautiful Simple**

The Simplicity Collection's minimalist design and humble timelessness simply complement other designs in the washroom.

**SIMPLICITY™ COLLECTION**  
**ALL STAINLESS STEEL IS TYPE 304 WITH SATIN FINISH,**  
**UNLESS OTHERWISE NOTED.**



**PAPER TOWEL  
DISPENSERS**



**PAPER TOWEL  
DISPENSERS**



**SOAP  
DISPENSERS**



**6467**  
**SIMPLICITY™ RECESSED**  
**PAPER TOWEL DISPENSER AND**  
**WASTE RECEPTACLE**

**800** MULTI-FOLD  
 OR 600 C-FOLD  
 PAPER TOWELS

**4.2 gal.**  
 WASTE CAPACITY  
 (16 L)

**Model Options:**

- 6467-41PC** Matte Black
- 6467-9** Surface mounted with a stainless steel collar.
- 6467-9-41PC** Surface mounted with a matte black stainless steel collar.

**Unit Size:**  
 13" x 55" x 4¾"  
 (330 x 1397 x 121 mm)

**Wall Opening:**  
 11½" x 53½" x 4"  
 (292 x 1359 x 102 mm)



**64676**  
**SIMPLICITY™ RECESSED**  
**PAPER TOWEL DISPENSER AND**  
**WASTE RECEPTACLE**

**800** MULTI-FOLD  
 OR 600 C-FOLD  
 PAPER TOWELS

**7 gal.**  
 WASTE CAPACITY  
 (26.5 L)

**Model Options:**

- 64676-2** Semi-recessed with a stainless steel collar.
- 64676-9** Surface mounted with a stainless steel collar.

**Unit Size:**  
 13" x 55" x 6½"  
 (330 x 1397 x 165 mm)

**Wall Opening:**  
 11½" x 53½" x 6"  
 (292 x 1359 x 152 mm)



**6462**  
**SIMPLICITY™ RECESSED**  
**PAPER TOWEL DISPENSER AND**  
**WASTE RECEPTACLE**

**800** MULTI-FOLD  
 OR 600 C-FOLD  
 PAPER TOWELS

**9 gal.**  
 WASTE CAPACITY  
 (34 L)

**Model Options:**

- 6462-2** Semi-recessed with a stainless steel collar.
- 6462-9** Surface mounted with a stainless steel collar.

**Unit Size:**  
 17¼" x 54" x 6½"  
 (438 x 1372 x 165 mm)

**Wall Opening:**  
 15¾" x 52½" x 6"  
 (400 x 1335 x 152 mm)



**64623**  
SIMPLICITY™ RECESSED PAPER TOWEL DISPENSER  
AND WASTE RECEPTACLE

**475** MULTI-FOLD  
OR 350 C-FOLD  
PAPER TOWELS

**2.2 gal.**  
WASTE CAPACITY  
(8.4 L)

**MANUAL**  
DISPENSING

**Model Options:**  
**64623-41PC** Matte Black.  
**64623-9** Surface mounted with a stainless steel collar.  
**64623-9-41PC** Surface mounted with a matte black stainless steel collar.

**Unit Size:**  
14¼" x 28" x 4¾"  
(362 x 711 x 121 mm)

**Wall Opening:**  
12¾" x 26½" x 4¼"  
(324 x 673 x 108 mm)



**6452**  
SIMPLICITY™ RECESSED PAPER TOWEL DISPENSER

**800** MULTI-FOLD  
OR 600 C-FOLD  
PAPER TOWELS

**MANUAL**  
DISPENSING

**Model Option:**  
**6452-9** Surface mounted with a stainless steel collar.

**Unit Size:**  
14¼" x 28" x 4½"  
(362 x 711 x 114 mm)

**Wall Opening:**  
12¾" x 26½" x 4¼"  
(324 x 673 x 108 mm)



**6457**  
SIMPLICITY™ RECESSED PAPER TOWEL DISPENSER

**475** MULTI-FOLD  
OR 350 C-FOLD  
PAPER TOWELS

**MANUAL**  
DISPENSING

**Unit Size:**  
12¾" x 17¼" x 4½"  
(324 x 438 x 114 mm)

**Wall Opening:**  
11¼" x 15¼" x 4¼"  
(286 x 400 x 108 mm)



**6459**  
SIMPLICITY™ RECESSED WASTE RECEPTACLE

**4 gal.**  
WASTE CAPACITY  
(15 L)

**Unit Size:**  
14¼" x 28" x 4½"  
(362 x 711 x 114 mm)

**Wall Opening:**  
12¾" x 26½" x 4¼"  
(324 x 673 x 108 mm)



**6474**  
**SIMPLICITY™ RECESSED**  
**WASTE RECEPTACLE**

**12 gal.**

**WASTE CAPACITY**  
 (45.4 L)

**Model Options:**

- 6474-41PC** Matte Black.
- 6474-2** Semi-recessed with a stainless steel collar.
- 6474-2-41PC** Matte Black.

**Unit Size:**

17¼" x 40" x 6¼"  
 (438 x 1016 x 171 mm)

**Wall Opening:**

15¾" x 38½" x 6¼"  
 (400 x 978 x 159 mm)



**64696A**  
**SIMPLICITY™ AUTOMATIC**  
**RECESSED ROLL PAPER**  
**TOWEL DISPENSER AND**  
**WASTE RECEPTACLE**

**UP TO 800 ft. 9.9 gal.**  
**(244 M) LONG ROLL WASTE CAPACITY**  
**TOWEL CAPACITY (37.3 L)**

**SUFFIX OPTIONS FOR**  
**POWER/MOUNTING:**

**[A, A-6, A-9, AC, AC-6, AC-9]**

**A:** Powered by 4 D-size batteries (not included).

**AC:** Powered by AC plug-in adapter.

**-6:** Semi-recessed with a stainless steel collar.

**-9:** Surface mounted with a stainless steel collar.

**Unit Size:**

16⅞" x 41¼" x 10¼"  
 (408 x 1048 x 261 mm)

**Wall Opening:**

14⅞" x 39¾" x 10"  
 (371 x 1010 x 254 mm)



**645210A**  
**SIMPLICITY™ AUTOMATIC**  
**RECESSED ROLL PAPER**  
**TOWEL DISPENSER**

**UP TO 800 ft. NO-TOUCH**  
**(244 M) LONG ROLL DISPENSING**  
**TOWEL CAPACITY**

**SUFFIX OPTIONS FOR**  
**POWER/MOUNTING:**

**[A, A-6, A-9, AC, AC-6, AC-9]**

**A:** Powered by 4 D-size batteries (not included).

**AC:** Powered by AC plug-in adapter.

**-6:** Semi-recessed with a stainless steel collar.

**-9:** Surface mounted with a stainless steel collar.

**Unit Size:**

16⅞" x 28" x 9"  
 (408 x 711 x 229 mm)

**Wall Opening:**

15¾" x 26½" x 10¼"  
 (400 x 673 x 260 mm)



**68523A-4**  
SIMPLICITY™ AUTOMATIC SEMI-RECESSED ROLL PAPER TOWEL DISPENSER

**UP TO 800 ft. NO-TOUCH**  
(244 M) LONG ROLL DISPENSING TOWEL CAPACITY

**Model Options:**

- 68523A battery operated, surface mounted.
- 68523AC roll towel dispenser, 110-240 VAC, surface mounted.
- 68523AC-4 roll towel dispenser, 110-240 VAC, semi-recessed.

**Unit Size:**  
17<sup>1</sup>/<sub>8</sub>" x 20<sup>3</sup>/<sub>8</sub>" x 9<sup>1</sup>/<sub>2</sub>"  
(440 x 518 x 241 mm)

**Wall Opening:**  
15<sup>3</sup>/<sub>8</sub>" x 19" x 4"  
(391 x 483 x 102 mm)



**645224AC**  
SIMPLICITY™ AUTOMATIC RECESSED ROLL PAPER TOWEL DISPENSER

**UP TO 800 ft. NO-TOUCH**  
(244 M) LONG ROLL DISPENSING TOWEL CAPACITY

**SUFFIX OPTIONS FOR POWER/ MOUNTING: [A, A-6, AC, AC-6, AC-9]**

- AC: Powered by AC plug-in adapter.
- 6: Semi-recessed with a stainless steel collar.
- 9: Surface mounted with a stainless steel collar.

**Unit Size:**  
17<sup>1</sup>/<sub>4</sub>" x 30<sup>1</sup>/<sub>2</sub>" x 10<sup>1</sup>/<sub>4</sub>"  
(438 x 775 x 260 mm)

**Wall Opening:**  
15<sup>3</sup>/<sub>4</sub>" x 29" x 4"  
(400 x 737 x 102 mm)



**646924A**  
SIMPLICITY™ AUTOMATIC RECESSED ROLL PAPER TOWEL DISPENSER AND WASTE RECEPTACLE

**UP TO 800 ft. 12 gal.**  
(244 M) LONG ROLL DISPENSING TOWEL CAPACITY WASTE CAPACITY (45.4 L)

**SUFFIX OPTIONS FOR POWER/ MOUNTING: [A, A-9, AC, AC-9]**

- A: Powered by 4 D-size batteries (not included).
- AC: Powered by AC plug-in adapter.
- 9: Surface mounted with a stainless steel collar.

**Unit Size:**  
17<sup>1</sup>/<sub>4</sub>" x 56" x 10<sup>1</sup>/<sub>4</sub>"  
(438 x 1422 x 260 mm)

**Wall Opening:**  
15<sup>3</sup>/<sub>4</sub>" x 54<sup>1</sup>/<sub>2</sub>" x 4"  
(400 x 1384 x 102 mm)



**0326**

**SIMPLICITY™ HORIZONTAL RECESSED LIQUID SOAP DISPENSER**

**57 oz.**  
CAPACITY

**Overall Dimensions:**  
10¼" x 6" x 4½"  
(260 x 152 x 115 mm)

**Wall Opening:**  
9" x 4⅞" x 4"  
(229 x 124 x 102 mm)

**Sput Projection:** 2½" (64 mm)



**64696**

**SIMPLICITY™ RECESSED ROLL PAPER TOWEL DISPENSER AND WASTE RECEPTACLE**

**UP TO 800 ft.** **9.4 gal.**  
(244 M) LONG ROLL TOWEL CAPACITY WASTE CAPACITY (36 L)

**Model Options:**  
**64696-6** Semi-recessed with a stainless steel collar.  
**64696-9** Surface mounted with a stainless steel collar.

**Unit Size:**  
16⅞" x 41¼" x 9⅞"  
(408 x 1048 x 245 mm)

**Wall Opening:**  
14⅞" x 39¾" x 9¼"  
(371 x 1010 x 235 mm)



**64672-1**

**SIMPLICITY™ RECESSED 3-IN-1 PAPER TOWEL DISPENSER, HIGH-SPEED HAND DRYER, AND WASTE RECEPTACLE**

**500 MULTI-FOLD** **6.8 gal.**  
OR 400 C-FOLD PAPER TOWELS WASTE CAPACITY (26 L)

**Model Options:**  
**64672-2** Dryer Voltage is 208-240 V Dryer.  
**64672** Cabinet only—no hand dryer included.  
**64672-41PC** Cabinet Only—Matte Black.

**Unit Size:**  
15⅞" x 55⅞" x 7½"  
(391 x 1407 x 191 mm)

**Wall Opening:**  
14⅞" x 54⅞" x 7¼"  
(358 x 1381 x 184 mm)

**Noise Level:** 68.9-74.3 dBA



**0135-1**  
**TURBO-TUFF™ RECESSED HIGH-SPEED**  
**ADA HAND DRYER (110-120V)**

**<15 sec.**  
 DRYING TIME

**68.9-74.3 dBA**  
 NOISE LEVEL

**Auto Shut Off:** 60 seconds

**Model Options:**  
**0135-2** Voltage is 208-240 V

**Unit Size:**  
 12<sup>19</sup>/<sub>32</sub>" x 15<sup>3</sup>/<sub>4</sub>" x 4<sup>1</sup>/<sub>32</sub>"  
 (320 x 400 x 102 mm)

**Wall Opening:**  
 12<sup>5</sup>/<sub>16</sub>" x 15<sup>3</sup>/<sub>16</sub>" x 3<sup>7</sup>/<sub>8</sub>"  
 (313 x 386 x 98 mm)

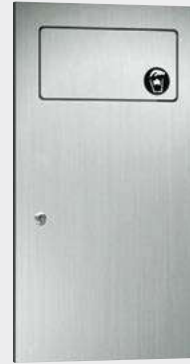

**6471**  
**SIMPLICITY™ RECESSED SANITARY NAPKIN DISPOSAL**

**1.4 gal.**  
 WASTE CAPACITY  
 (5.4 L)

**Unit Size:**  
 10<sup>5</sup>/<sub>8</sub>" x 19<sup>5</sup>/<sub>8</sub>" x 4<sup>1</sup>/<sub>2</sub>"  
 (270 x 498 x 114 mm)

**Wall Opening:**  
 9<sup>1</sup>/<sub>8</sub>" x 18<sup>1</sup>/<sub>8</sub>" x 4"  
 (232 x 460 x 102 mm)



**6477**  
**SIMPLICITY™ RECESSED TOILET SEAT COVER DISPENSER**

**500** SINGLE  
 OR HALF-FOLD  
 PAPER SEAT  
 COVERS

**Unit Size:**  
 17<sup>1</sup>/<sub>4</sub>" x 12<sup>3</sup>/<sub>4</sub>" x 2<sup>7</sup>/<sub>8</sub>"  
 (438 x 324 x 73 mm)

**Wall Opening:**  
 15<sup>3</sup>/<sub>4</sub>" x 11<sup>1</sup>/<sub>2</sub>" x 2<sup>3</sup>/<sub>8</sub>"  
 (400 x 292 x 60 mm)



**6468**  
**SIMPLICITY™ RECESSED DUAL NAPKIN/TAMPON VENDOR**

**27**  
 TAMPON  
 CAPACITY

**Model Option:**  
**64684** designed for 4" (102 mm) wall opening; dispenses 15 napkins and 23 tampons.

**Unit Size:**  
 17<sup>1</sup>/<sub>4</sub>" x 27<sup>1</sup>/<sub>4</sub>" x 6<sup>1</sup>/<sub>2</sub>"  
 (438 x 692 x 165 mm)

**Wall Opening:**  
 16" x 26" x 6<sup>1</sup>/<sub>4</sub>"  
 (406 x 660 x 159 mm)



## ROVAL™ COLLECTION DETAILS



### ARCH-SHAPED SURFACES

Contrasting character of outstanding arch-shaped surfaces.



### INTEGRAL LOCKING SYSTEM

Our durable, integral locking system prevents tampering and theft.

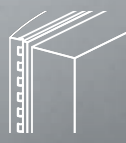

### STAKED PIANO HINGES

Our heavy-duty staked piano hinges provide security and a neat appearance, and they stand up to heavy use.



### REMOVABLE WASTE RECEPTACLE

Fully removable waste cans allow contents to be easily discarded for efficient ongoing maintenance and cleanliness.

# **ROVAL™** COLLECTION

## **Overarching The Form**

The Roval Collection's arch-shaped surfaces offer a dialogue of tactile and visual contrast in the washroom, transforming accessories into an aesthetic gesture.



**MANUAL AND  
AUTOMATIC  
PAPER TOWEL/  
TOILET TISSUE  
DISPENSERS**



**MIRRORS**



**AUTOMATIC  
HAND DRYERS**



**20469**

**ROVAL™ RECESSED PAPER TOWEL DISPENSER AND WASTE RECEPTACLE**

**800** MULTI-FOLD  
OR 600 C-FOLD  
PAPER TOWELS

**14.8 gal.**  
WASTE CAPACITY  
(56 L)

**MANUAL**  
DISPENSING

**Model Option:**

**20469-9** Surface mounted with a stainless steel collar.

**Unit Size:**

17<sup>3</sup>/<sub>8</sub>" x 56<sup>1</sup>/<sub>16</sub>" x 9"  
(441 x 1424 x 228 mm)

**Wall Opening:**

15<sup>5</sup>/<sub>8</sub>" x 54<sup>3</sup>/<sub>8</sub>" x 4"  
(397 x 1381 x 102 mm)



**204623**

**ROVAL™ RECESSED PAPER TOWEL DISPENSER AND REMOVABLE WASTE RECEPTACLE**

**475** MULTI-FOLD  
OR 350 C-FOLD  
PAPER TOWELS

**3 gal.**  
WASTE CAPACITY  
(11.2 L)

**MANUAL**  
DISPENSING

**Model Option:**

**204623-9** Surface mounted with a stainless steel collar.

**Unit Size:**

12<sup>3</sup>/<sub>4</sub>" x 28" x 6<sup>1</sup>/<sub>2</sub>"  
(325 x 710 x 165 mm)

**Wall Opening:**

11<sup>1</sup>/<sub>4</sub>" x 26<sup>7</sup>/<sub>16</sub>" x 3<sup>15</sup>/<sub>16</sub>"  
(286 x 672 x 100 mm)

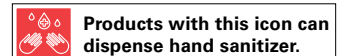



**20210**  
**ROVAL™ SURFACE MOUNTED PAPER TOWEL DISPENSER**

**525** MULTI-FOLD **MANUAL**  
 OR 400 C-FOLD PAPER TOWELS **DISPENSING**

**Overall Dimensions:**  
 11<sup>1</sup>/<sub>16</sub>" x 13<sup>9</sup>/<sub>16</sub>" x 4<sup>7</sup>/<sub>16</sub>"  
 (281 x 345 x 124 mm)



**20826**  
**ROVAL™ SURFACE MOUNTED WASTE RECEPTACLE**

**12.8 gal.**  
**WASTE CAPACITY**  
 (48.4 L)

**Model Option:**  
**20826-T** Closed top, spring-loaded door. Capacity 12.8 gal. (48.4 L).

**Overall Dimensions:**  
 15<sup>1</sup>/<sub>8</sub>" x 23" x 8<sup>1</sup>/<sub>2</sub>"  
 (384 x 584 x 216 mm)



**9343**  
**HORIZONTAL SURFACE MOUNTED SOAP DISPENSER**

**48 oz.**  
**CAPACITY**

**Model Option:**  
**9343-41** Matte Black.

**Overall Dimensions:**  
 7<sup>1</sup>/<sub>4</sub>" x 6<sup>1</sup>/<sub>2</sub>" x 3<sup>1</sup>/<sub>16</sub>"  
 (184 x 165 x 94 mm)

**Spout Projection:**  
 1<sup>5</sup>/<sub>16</sub>" (24 mm)



**20364**  
**ROVAL™ AUTOMATIC SURFACE MOUNTED LIQUID SOAP AND GEL HAND SANITIZER DISPENSER**

**34 oz. NO-TOUCH**  
**CAPACITY DISPENSING**

**Overall Dimensions:**  
 5<sup>1</sup>/<sub>2</sub>" x 10<sup>13</sup>/<sub>16</sub>" x 4"  
 (140 x 274 x 102 mm)



**20365**  
**ROVAL™ AUTOMATIC SURFACE MOUNTED FOAM SOAP AND HAND SANITIZER DISPENSER**

**34 oz. NO-TOUCH**  
**CAPACITY DISPENSING**

**Overall Dimensions:**  
 5<sup>1</sup>/<sub>2</sub>" x 10<sup>13</sup>/<sub>16</sub>" x 4"  
 (140 x 274 x 102 mm)



**20363**  
**ROVAL™ SURFACE MOUNTED LIQUID SOAP DISPENSER**

**57 oz.**  
**CAPACITY**

**Overall Dimensions:**  
 5<sup>1</sup>/<sub>2</sub>" x 10<sup>13</sup>/<sub>16</sub>" x 4"  
 (139 x 274 x 102 mm)

**Spout Projection:**  
 1<sup>5</sup>/<sub>16</sub>" (24 mm)



**20452**  
**ROVAL™ RECESSED PAPER TOWEL DISPENSER**

**800** MULTI-FOLD  
OR 600 C-FOLD  
PAPER TOWELS

**MANUAL**  
DISPENSING

**Overall Dimensions:**  
12<sup>3</sup>/<sub>4</sub>" x 28" x 5<sup>7</sup>/<sub>16</sub>"  
(324 x 711 x 137 mm)

**Wall Opening:**  
11<sup>1</sup>/<sub>4</sub>" x 26<sup>7</sup>/<sub>16</sub>" x 3<sup>15</sup>/<sub>16</sub>"  
(286 x 672 x 100 mm)



**20458**  
**ROVAL™ SEMI-RECESSED REMOVABLE  
WASTE RECEPTACLE**

**11.2 gal.**  
WASTE CAPACITY  
(42.6 L)

**Unit Size:**  
17<sup>3</sup>/<sub>8</sub>" x 27<sup>3</sup>/<sub>4</sub>" x 8<sup>15</sup>/<sub>16</sub>"  
(441 x 705 x 227 mm)

**Wall Opening:**  
15<sup>3</sup>/<sub>4</sub>" x 26" x 3<sup>15</sup>/<sub>16</sub>"  
(400 x 660 x 100 mm)



**204692A**

**ROVAL™ AUTOMATIC RECESSED ROLL PAPER TOWEL DISPENSER AND WASTE RECEPTACLE**

**UP TO 800 ft.**  
(244 M) LONG ROLL  
TOWEL CAPACITY

**17.8 gal.**  
WASTE CAPACITY  
(67.2 L)

**NO-TOUCH**  
DISPENSING

**SUFFIX OPTIONS FOR POWER/MOUNTING:**  
[A, A-6, A-9, AC, AC-6, AC-9]

- A: Powered by 4 D-size batteries (not included).
- AC: Powered by AC plug-in adapter.
- 6: Semi-recessed with a stainless steel collar.
- 9: Surface mounted with a stainless steel collar.

**Unit Size:**  
17<sup>3</sup>/<sub>8</sub>" x 56<sup>1</sup>/<sub>16</sub>" x 11<sup>11</sup>/<sub>16</sub>"  
(441 x 1424 x 297 mm)

**Wall Opening:**  
15<sup>13</sup>/<sub>16</sub>" x 54<sup>11</sup>/<sub>16</sub>" x 10"  
(402 x 1389 x 254 mm)



**2046921A**

**ROVAL™ AUTOMATIC RECESSED ROLL PAPER TOWEL DISPENSER AND WASTE RECEPTACLE FOR ADA COMPLIANCE**

**UP TO 800 ft.**  
(244 M) LONG ROLL  
TOWEL CAPACITY

**13.5 gal.**  
WASTE CAPACITY  
(51.1 L)

**NO-TOUCH**  
DISPENSING

**SUFFIX OPTIONS FOR POWER/MOUNTING:**  
[A, A-6, A-9, AC, AC-6, AC-9]

- A: Powered by 4 D-size batteries (not included).
- AC: Powered by AC plug-in adapter.
- 6: Semi-recessed with a stainless steel collar.
- 9: Surface mounted with a stainless steel collar.

**Unit Size:**  
17<sup>3</sup>/<sub>8</sub>" x 56<sup>1</sup>/<sub>16</sub>" x 11<sup>11</sup>/<sub>16</sub>"  
(441 x 1424 x 296 mm)

**Wall Opening:**  
15<sup>13</sup>/<sub>16</sub>" x 54<sup>11</sup>/<sub>16</sub>" x 10"  
(402 x 1389 x 254 mm)



**204523A**  
**ROVAL™ AUTOMATIC RECESSED ROLL PAPER TOWEL DISPENSER**

**UP TO 800 ft. NO-TOUCH**  
**(244 M) LONG ROLL DISPENSING**  
**TOWEL CAPACITY**

**SUFFIX OPTIONS FOR POWER/MOUNTING: [A, A-6, A-9, AC, AC-6, AC-9]**

**A:** Powered by 4 D-size batteries (not included).

**AC:** Powered by AC plug-in adapter.

**-6:** Semi-recessed with a stainless steel collar.

**-9:** Surface mounted with a stainless steel collar.

**Unit Size:**  
17<sup>3</sup>/<sub>8</sub>" x 27<sup>3</sup>/<sub>4</sub>" x 11<sup>1</sup>/<sub>16</sub>"  
(441 x 705 x 297 mm)

**Wall Opening:**  
15<sup>3</sup>/<sub>4</sub>" x 26" x 10"  
(400 x 660 x 254 mm)



**20852**  
**ROVAL™ SURFACE MOUNTED SANITARY WASTE RECEPTACLE**

**1.0 gal.**  
**WASTE CAPACITY**  
(3.7 L)

**Overall Dimensions:**  
7<sup>1</sup>/<sub>4</sub>" x 10" x 3<sup>1</sup>/<sub>2</sub>"  
(185 x 253 x 89 mm)



**20477-SM**  
**ROVAL™ SURFACE MOUNTED SEAT COVER DISPENSER**

**250**  
**SINGLE**  
**OR HALF-FOLD**  
**PAPER SEAT**  
**COVERS**

**Overall Dimensions:**  
15<sup>3</sup>/<sub>4</sub>" x 11" x 2<sup>3</sup>/<sub>8</sub>"  
(400 x 280 x 60 mm)



**20030**  
**ROVAL™ SURFACE MOUNTED TWIN HIDE-A-ROLL TOILET TISSUE DISPENSER**

**2**  
**TOILET PAPER**  
**CAPACITY (ROLLS)**

**Model Option:**  
**20031** With flange for semi-recessed mounting.

**Overall Dimensions:**  
6<sup>1</sup>/<sub>16</sub>" x 12<sup>1</sup>/<sub>8</sub>" x 6<sup>1</sup>/<sub>2</sub>"  
(154 x 308 x 165 mm)



**20470**  
**ROVAL™ RECESSED SANITARY NAPKIN DISPOSAL**

**1.0 gal.**  
**WASTE CAPACITY**  
(3.7 L)

**Unit Size:**  
12<sup>13</sup>/<sub>16</sub>" x 11" x 5<sup>7</sup>/<sub>16</sub>"  
(325 x 280 x 138 mm)

**Wall Opening:**  
15<sup>3</sup>/<sub>4</sub>" x 26" x 3<sup>1</sup>/<sub>16</sub>"  
(400 x 660 x 100 mm)



**20199**  
**ROVAL™ SEMI-RECESSED  
 HIGH-SPEED HAND DRYER**

**<15 sec.**  
 DRYING TIME

**69 dBA**  
 NOISE LEVEL

**Voltage:** 120 V (-1) and 240 V (-2)

**Unit Size:**  
 11" x 15½" x 5<sup>23</sup>/<sub>32</sub>"  
 (279 x 394 x 145 mm)

**Wall Opening:**  
 10½" x 14<sup>5</sup>/<sub>8</sub>" x 3¼"  
 (267 x 371 x 83 mm)



**20655**  
**ROVAL™ STAINLESS STEEL MIRROR WITH  
 INTEGRAL SHELF**

**15 YEAR**  
 WARRANTY

**Model Options:**  
 20650 Mirror without shelf.  
 20655-1830 - 18" wide x 30" high (457 x 762 mm).  
 20655-1836 - 18" wide x 36" high (457 x 914 mm).  
 20655-2436 - 24" wide x 36" high (610 x 914 mm).



**20692 SERIES**  
**ROVAL™ SURFACE MOUNTED SHELF, 6" DEPTH**

For various lengths add suffix-6XX.

See chart for standard sizes on page 90.



**204684**  
**ROVAL™ RECESSED DUAL SANITARY NAPKIN  
 AND TAMPON VENDOR**

**22**  
 TAMPON  
 CAPACITY

**Model Option:**  
 204684-9 Surface mounted with a stainless steel collar.

**Unit Size:**  
 17<sup>7</sup>/<sub>16</sub>" x 27<sup>3</sup>/<sub>4</sub>" x 5<sup>5</sup>/<sub>8</sub>"  
 (440 x 705 x 143 mm)

**Wall Opening:**  
 15<sup>3</sup>/<sub>4</sub>" x 26<sup>1</sup>/<sub>8</sub>" x 4"  
 (397 x 664 x 102 mm)

## TRADITIONAL™ COLLECTION DETAILS



### SAFE, EASY DISPENSING

Towel dispensers have hemmed opening for safe, easy dispensing, minimizing waste, and ensuring hygienic use.



### EASY LIFT OUT RECEPTACLE

Fully removable stainless steel waste cans allow contents to be easily discarded for efficient ongoing maintenance and cleanliness.

# **TRADITIONAL™** COLLECTION

## **The Original**

The time-honored Traditional Collection provides exceptional value, offering a broad array of items in a handcrafted style with pure original beauty.



**PAPER TOWEL  
DISPENSERS**



**WASTE  
RECEPTACLES**



**0469**

**TRADITIONAL™ RECESSED PAPER TOWEL DISPENSER AND WASTE RECEPTACLE**

**800** MULTI-FOLD  
OR 600 C-FOLD  
PAPER TOWELS

**12 gal.**  
WASTE CAPACITY  
(46 L)

**MANUAL**  
DISPENSING

**Model Options:**

- 0469-2** Semi-recessed with a stainless steel collar.
- 0469-9** Surface mounted with a stainless steel collar.
- 0469-BL** 18 gal. (68 L) waste receptacle. Projects 8" (205 mm) from wall.

**Unit Size:**

17¼" x 56" x 4¼"  
(438 x 1422 x 108 mm)

**Wall Opening:**

15¾" x 54½" x 4"  
(400 x 1384 x 102 mm)



**0462-AD**

**TRADITIONAL™ RECESSED PAPER TOWEL DISPENSER AND WASTE RECEPTACLE**

**475** MULTI-FOLD  
OR 350 C-FOLD  
PAPER TOWELS

**2 gal.**  
WASTE CAPACITY  
(7.6 L)

**MANUAL**  
DISPENSING

**Model Option:**

- 0462-AD-9** Surface mounted with a stainless steel collar.

**Unit Size:**

14¼" x 28" x 4¼"  
(362 x 711 x 108 mm)

**Wall Opening:**

12¾" x 26½" x 4"  
(324 x 673 x 102 mm)



**04697**

**TRADITIONAL™ RECESSED PAPER TOWEL DISPENSER AND WASTE RECEPTACLE**

**800** MULTI-FOLD  
OR 600 C-FOLD  
PAPER TOWELS

**12 gal.**  
WASTE CAPACITY  
(46 L)

**MANUAL**  
DISPENSING

**Model Options:**

- 04697-4** Semi-recessed with a stainless steel collar.
- 04697-9** Surface mounted with a stainless steel collar.
- 04697-BL** 18 gal. (68 L) waste receptacle, projects 4" (102 mm) from wall.

**Unit Size:**

17¼" x 56" x 7¼"  
(438 x 1422 x 184 mm)

**Wall Opening:**

15¾" x 54½" x 7¼"  
(400 x 1384 x 184 mm)



**0467**

**TRADITIONAL™ RECESSED PAPER TOWEL DISPENSER AND WASTE RECEPTACLE**

**800** MULTI-FOLD  
OR 600 C-FOLD  
PAPER TOWELS

**7 gal.**  
WASTE CAPACITY  
(26 L)

**MANUAL**  
DISPENSING

**Model Options:**

- 0467-2** Semi-recessed with a stainless steel collar.
- 0467-9** Surface mounted with a stainless steel collar.

**Unit Size:**

13" x 55" x 6½"  
(330 x 1397 x 165 mm)

**Wall Opening:**

11½" x 53½" x 6¼"  
(292 x 1359 x 159 mm)



**0210**  
**TRADITIONAL™ SURFACE MOUNTED  
 PAPER TOWEL DISPENSER**

**525** MULTI-FOLD  
 OR 400 C-FOLD  
 PAPER TOWELS

**MANUAL  
 DISPENSING**

**Model Option:**  
**0210-41** Matte Black.

**Overall Dimensions:**  
 11 1/8" x 14 5/8" x 4"  
 (282 x 371 x 101 mm)



**0457**  
**TRADITIONAL™ RECESSED PAPER TOWEL DISPENSER**

**500** MULTI-FOLD  
 OR 350 C-FOLD  
 PAPER TOWELS

**MANUAL  
 DISPENSING**

**Model Option:**  
**0457-9** Surface mounted with a stainless steel collar.

**Unit Size:**  
 12 3/4" x 17 1/4" x 4 1/4"  
 (324 x 438 x 108 mm)

**Wall Opening:**  
 11 1/4" x 15 3/4" x 4"  
 (286 x 400 x 102 mm)



**0452**  
**TRADITIONAL™ RECESSED PAPER TOWEL DISPENSER**

**800** MULTI-FOLD  
 OR 600 C-FOLD  
 PAPER TOWELS

**MANUAL  
 DISPENSING**

**Model Option:**  
**0452-9** Surface mounted with a stainless steel collar.

**Unit Size:**  
 14 1/4" x 28" x 4 1/4"  
 (326 x 711 x 108 mm)

**Wall Opening:**  
 12 3/4" x 26 1/2" x 4"  
 (324 x 673 x 102 mm)



**0439**  
**TRADITIONAL™ PAPER TOWEL DISPENSER  
 FOR BEHIND THE MIRROR**

**800** MULTI-FOLD  
 OR 600 C-FOLD  
 PAPER TOWELS

**MANUAL  
 DISPENSING**

**FOR BEHIND  
 THE MIRROR**

**Overall Dimensions:**  
 11 1/2" x 18" x 4 1/2"  
 (292 x 457 x 108 mm)



**0215**  
**TRADITIONAL™ SURFACE MOUNTED**  
**PAPER TOWEL DISPENSER – PETITE**

**275** MULTI-FOLD  
 OR 200 C-FOLD  
 PAPER TOWELS

**MANUAL**  
 DISPENSING

**Overall Dimensions:**  
 11" x 8" x 4"  
 (279 x 203 x 102 mm)



**0245-SS**  
**TRADITIONAL™ SURFACE MOUNTED**  
**PAPER TOWEL DISPENSER**

**400**  
 SINGLE-FOLD  
 PAPER TOWELS

**MANUAL**  
 DISPENSING

**Overall Dimensions:**  
 11¼" x 6¼" x 5⅝"  
 (285 x 160 x 143 mm)



**1002**  
**TRADITIONAL™ COUNTER TOP MOUNTED**  
**PAPER TOWEL DISPENSER**

**UP TO 300**  
 MULTI-FOLD  
 PAPER TOWELS

**MANUAL**  
 DISPENSING

**COUNTER**  
 MOUNTED

**Unit Size:**  
 14¼" x 6" x ⅜"  
 (362 x 152 x 2 mm)

**Counter Opening:**  
 12½" x 4¼"  
 (318 x 108 mm)



**1001**  
**TRADITIONAL™ COUNTER TOP MOUNTED**  
**PAPER TOWEL DISPENSER/WASTE RECEPTACLE**

**UP TO 300**  
 MULTI-FOLD  
 PAPER TOWELS

**7.5 gal.**  
 WASTE CAPACITY  
 (28 L)

**COUNTER**  
 MOUNTED

**Unit Size:**  
 14¼" x 15" x ⅜"  
 (362 x 381 x 2 mm)

**Counter Opening:**  
 12½" x 13½"  
 (318 x 343 mm)



**04692A**  
**TRADITIONAL™ AUTOMATIC  
 RECESSED ROLL PAPER  
 TOWEL DISPENSER AND  
 WASTE RECEPTACLE**

**UP TO 800 ft. NO-TOUCH 17 gal.**  
 (244 M) LONG ROLL DISPENSING WASTE CAPACITY  
 TOWEL CAPACITY (64 L)

**SUFFIX OPTIONS FOR POWER/  
 MOUNTING:**  
**[A, A-6, A-9, AC, AC-6, AC-9]**

- A:** Powered by 4 D-size batteries (not included).
- AC:** Powered by AC plug-in adapter.
- 6:** Semi-recessed with a stainless steel collar.
- 9:** Surface mounted with a stainless steel collar.
- 04692:** Mechanical lever dispenser.

**Unit Size:**  
 17¼" x 56" x 10¼"  
 (438 x 1422 x 260 mm)

**Wall Opening:**  
 15¾" x 54½" x 10"  
 (400 x 1384 x 254 mm)



**046921A**  
**TRADITIONAL™ AUTOMATIC  
 RECESSED ROLL PAPER  
 TOWEL DISPENSER AND  
 WASTE RECEPTACLE**

**UP TO 800 ft. NO-TOUCH 12 gal.**  
 (244 M) LONG ROLL DISPENSING WASTE CAPACITY  
 TOWEL CAPACITY (45.4 L)

**SUFFIX OPTIONS FOR POWER/  
 MOUNTING:**  
**[A, A-6, A-9, AC, AC-6, AC-9]**

- A:** Powered by 4 D-size batteries (not included).
- AC:** Powered by AC plug-in adapter.
- 6:** Semi-recessed with a stainless steel collar.
- 9:** Surface mounted with a stainless steel collar.
- 046921:** Mechanical lever dispenser.

**Unit Size:**  
 17¼" x 56" x 10¼"  
 (438 x 1422 x 260 mm)

**Wall Opening:**  
 15¾" x 54½" x 10¼"  
 (400 x 1384 x 260 mm)



**8523A**  
**TRADITIONAL™ AUTOMATIC  
 SURFACE MOUNTED ROLL PAPER  
 TOWEL DISPENSER**

**UP TO 800 ft. NO-TOUCH**  
 (244 M) LONG ROLL DISPENSING  
 TOWEL CAPACITY

**SUFFIX OPTIONS FOR POWER/  
 MOUNTING:**  
**[A, AC]**

- AC:** Powered by AC plug-in adapter.

**Unit Size:**  
 13" x 17¾" x 10½"  
 (330 x 451 x 267 mm)



**045210A**  
**TRADITIONAL™ AUTOMATIC**  
**RECESSED ROLL PAPER**  
**TOWEL DISPENSER**

**UP TO 800 ft. NO-TOUCH**  
 (244 M) LONG ROLL DISPENSING  
 TOWEL CAPACITY

**SUFFIX OPTIONS FOR**  
**POWER/MOUNTING:**  
**[A, A-6, A-9, AC, AC-6, AC-9]**

- A:** Powered by 4 D-size batteries (not included).
- AC:** Powered by AC plug-in adapter.
- 6:** Semi-recessed with a stainless steel collar.
- 9:** Surface mounted with a stainless steel collar.

**Unit Size:**  
 17¼" x 28" x 10"  
 (438 x 711 x 254 mm)

**Wall Opening:**  
 15¾" x 26½" x 10¼"  
 (400 x 673 x 260 mm)



**046926**  
**TRADITIONAL™ SEMI-RECESSED**  
**SPRING OPERATED NO-TOUCH**  
**ROLL PAPER TOWEL DISPENSER**  
**AND WASTE RECEPTACLE**

**UP TO 800 ft. NO-TOUCH 12 gal.**  
 (244 M) LONG ROLL DISPENSING WASTE CAPACITY  
 TOWEL CAPACITY (45.4 L)

**Unit Size:**  
 17¼" x 56" x 9¼"  
 (438 x 1422 x 235 mm)

**Wall Opening:**  
 15¾" x 54½" x 4"  
 (400 x 1384 x 102 mm)



**046924**  
**TRADITIONAL™ RECESSED**  
**ROLL PAPER TOWEL DISPENSER**  
**AND WASTE RECEPTACLE**

**UP TO 800 ft. 12 gal.**  
 (244 M) LONG ROLL WASTE CAPACITY  
 TOWEL CAPACITY (45.4 L)

**Model Options:**  
**046924-9** Surface Mounted with a stainless steel collar.

**Unit Size:**  
 17¼" x 56" x 10¼"  
 (438 x 1422 x 260 mm)

**Wall Opening:**  
 15¾" x 54½" x 4"  
 (400 x 1384 x 102 mm)



**8522**

**TRADITIONAL™ SURFACE MOUNTED ROLL PAPER TOWEL DISPENSER**

**UP TO 800 ft. (244 M) LONG ROLL TOWEL CAPACITY**     **MANUAL DISPENSING**

**Model Options:**

**8523A** Powered by 4 D-size batteries (not included).

**8523AC** Powered by AC plug-in adapter.

**Overall Dimensions:**

14" x 16" x 9½"  
(356 x 406 x 241 mm)



**8165**

**TRADITIONAL™ SURFACE MOUNTED ROLL PAPER TOWEL DISPENSER**

**1 PAPER TOWEL ROLL CAPACITY**     **MANUAL DISPENSING**

**Overall Dimensions:**

Unit measures 13" (330 mm) wide; projects 6" (152 mm) from wall.



**0828**

**TRADITIONAL™ SURFACE MOUNTED WASTE RECEPTACLE**

**6.5 gal. WASTE CAPACITY (24.8 L)**

**Overall Dimensions:**

14" x 18" x 6"  
(356 x 457 x 152 mm)



**0825**

**TRADITIONAL™ SURFACE MOUNTED WASTE RECEPTACLE**

**17 gal. WASTE CAPACITY (64 L)**

**Model Option:**

**0826** has 12 gal. (45.4 L) capacity with 15¼" x 23" x 8" (387 x 584 x 203 mm) dimensions.

**Overall Dimensions:**

15¾" x 21⅞" x 11¼"  
(400 x 556 x 298 mm)



**0827**

**TRADITIONAL™ SURFACE MOUNTED WASTE RECEPTACLE**

**2 gal. WASTE CAPACITY (7.6 L)**

**Overall Dimensions:**

10½" x 9" x 4¾"  
(267 x 229 x 121 mm)



**1003**

**TRADITIONAL™ COUNTER TOP MOUNTED WASTE RECEPTACLE**

**7.4 gal. WASTE CAPACITY (28 L)**     **COUNTER MOUNTED**

**Unit Size:**

14¼" x 10" x ⅜"  
(362 x 254 x 2 mm)

**Counter Opening:**

8¾" x 12½"  
(222 x 318 mm)



**1000**  
TRADITIONAL™ CIRCULAR  
COUNTER TOP WASTE CHUTE

**6" COUNTER**  
DIAMETER MOUNTED

**Model Option:**  
**1000A** has a 9" (229 mm) outside diameter with a counter opening of 8 1/8" (206 mm) diameter.

**Unit Size:**  
6 3/4" (171 mm)  
outside diameter

**Counter Opening:**  
5 3/4" (146 mm)  
diameter



**0834**  
TRADITIONAL™ FREESTANDING  
WASTE RECEPTACLE

**14 gal. FLOOR**  
WASTE CAPACITY STANDING  
(54 L)

**Model Option:**  
**0839** has 19 gal. (72 L) capacity with 12 3/8" x 32" x 12 1/2" (314 x 800 x 318 mm) dimensions.

**Overall Dimensions:**  
12 3/8" x 24" x 12 1/2"  
(314 x 609 x 318 mm)



**0834-T**  
TRADITIONAL™ FREESTANDING  
WASTE RECEPTACLE WITH DUAL  
SWING TOP

**14 gal. FLOOR**  
WASTE CAPACITY STANDING  
(54 L)

**Model Option:**  
**0839-T** has 19 gal. (72 L) capacity with 12 3/8" x 37 1/4" x 12 1/2" (314 x 946 x 318 mm) dimensions.

**Overall Dimensions:**  
12 3/8" x 29 3/4" x 12 1/2"  
(314 x 756 x 318 mm)



**0829**  
TRADITIONAL™ CORNER  
WASTE RECEPTACLE

**16 gal. CORNER-SURFACE**  
WASTE CAPACITY MOUNTED  
(60 L)

**Overall Dimensions:**  
15" x 23" x 14 1/2"  
(381 x 584 x 368 mm)



**0458**  
TRADITIONAL™ SEMI-RECESSED  
WASTE RECEPTACLE

**12 gal.**  
WASTE CAPACITY  
(46 L)

**Model Option:**  
**0458-9** Surface mounted with a stainless steel collar.

**Unit Size:**  
17 1/4" x 30 1/2" x 8 1/4" (438 x 775 x 210 mm)

**Wall Opening:**  
15 3/4" x 29" x (variable") (400 x 737 mm)  
\*0458 if 4" (102 mm) x 4" and 12 gals. (46 L);  
0458-CX if 1/2" (13 mm) x 7 1/2" (191 mm) and  
12 gals. (46 L); 0458-DX if 8" (203 mm) x 4"  
(102 mm) and 18 gals. (68 L)



**04733**  
TRADITIONAL™ RECESSED  
WASTE RECEPTACLE

**3 gal.**  
WASTE CAPACITY  
(11.4 L)

**Unit Size:**  
14 1/4" x 28" x 4 1/2"  
(362 x 711 x 114 mm)

**Wall Opening:**  
12 3/4" x 26 1/2" x 4"  
(324 x 673 x 102 mm)



# **MATTE BLACK** COLLECTION

## **The Trending Crossover**

The Matte Black Collection — a chic alternative of carefully curated versatility makes a statement in any setting. The boldness of black creates an air of sophistication, while the subtlety of the matte finish exudes warmth.



**PAPER TOWEL  
COMBINATION  
UNITS**



**SOAP  
DISPENSERS**



**BABY  
CHANGERS**



**0210-41**  
**MATTE BLACK SURFACE MOUNTED PAPER TOWEL DISPENSER**

**525** MULTI-FOLD **MANUAL**  
 OR 400 C-FOLD DISPENSING  
 PAPER TOWELS

**Overall Dimensions:**  
 11 1/8" x 14 5/8" x 4"  
 (282 x 371 x 101 mm)



**6467-41PC**  
**SIMPLICITY™ IN MATTE BLACK RECESSED PAPER TOWEL DISPENSER & WASTE RECEPTACLE**

**800** MULTI-FOLD **4.2 gal.**  
 OR 600 C-FOLD WASTE CAPACITY  
 PAPER TOWELS (16 L)

**Model Option:**  
**6467-9-41PC** Surface mounted with a matte black powder coated stainless steel collar.

**Unit Size:**  
 13" x 55" x 4 3/4"  
 (330 x 1397 x 121 mm)

**Wall Opening:**  
 11 1/2" x 53 1/2" x 4"  
 (292 x 1359 x 102 mm)



**64623-41PC**  
**SIMPLICITY™ IN MATTE BLACK RECESSED PAPER TOWEL DISPENSER AND WASTE RECEPTACLE**

**475** MULTI-FOLD **2.2 gal.**  
 OR 350 C-FOLD WASTE CAPACITY  
 PAPER TOWELS (8.4 L)

**Model Option:**  
**64623-9-41PC** Surface mounted with a matte black powder coated stainless steel collar.

**Unit Size:**  
 14 1/4" x 28" x 4 3/4"  
 (362 x 711 x 121 mm)

**Wall Opening:**  
 12 3/4" x 26 1/2" x 4 1/4"  
 (324 x 673 x 108 mm)



**64672-41PC**  
**SIMPLICITY™ IN MATTE BLACK**  
**RECESSED 3-IN-1 CABINET – PAPER**  
**TOWEL DISPENSER, WASTE**  
**RECEPTACLE, AND HIGH-SPEED**  
**HAND DRYER\***

**500** MULTI-FOLD  
 OR 400 C-FOLD  
 PAPER TOWELS

**6.8 gal.**  
 WASTE CAPACITY  
 (26 L)

\*Hand Dryer sold separately.

**Unit Size:**  
 15<sup>5</sup>/<sub>16</sub>" x 55<sup>3</sup>/<sub>16</sub>" x 7<sup>1</sup>/<sub>2</sub>"  
 (391 x 1407 x 191 mm)

**Wall Opening:**  
 14<sup>3</sup>/<sub>32</sub>" x 54<sup>3</sup>/<sub>16</sub>" x 7<sup>1</sup>/<sub>4</sub>"  
 (358 x 1381 x 184 mm)



**0362-41**  
**AUTOMATIC LIQUID SOAP AND**  
**GEL HAND SANITIZER DISPENSER**

**28 oz.** CAPACITY

**NO-TOUCH** DISPENSING

**BATTERY** POWERED

**Overall Dimensions:**  
 4<sup>13</sup>/<sub>16</sub>" x 10<sup>5</sup>/<sub>16</sub>" x 4<sup>1</sup>/<sub>8</sub>"  
 (122 x 270 x 105 mm)



**0347-41**  
**VERTICAL SOAP DISPENSER**

**0345-41**  
**HORIZONTAL SOAP DISPENSER**

**40 oz.** CAPACITY

**MANUAL** DISPENSING

**0347 Unit Size:**  
 4<sup>1</sup>/<sub>16</sub>" x 8<sup>3</sup>/<sub>16</sub>" x 3<sup>15</sup>/<sub>16</sub>"  
 (122 x 208 x 100 mm)

**0345 Unit Size:**  
 8<sup>3</sup>/<sub>16</sub>" x 4<sup>13</sup>/<sub>16</sub>" x 3<sup>15</sup>/<sub>16</sub>"  
 (208 x 122 x 100 mm)

**Spout Projection:**  
 1<sup>5</sup>/<sub>16</sub>" (24 mm)



**9343-41**  
LIQUID SOAP DISPENSER

**48 oz.**  
CAPACITY

**SURFACE**  
MOUNTED

**Overall Dimensions:**  
7<sup>1</sup>/<sub>4</sub>" x 6<sup>1</sup>/<sub>2</sub>" x 3<sup>1</sup>/<sub>16</sub>"  
(184 x 165 x 94 mm)

**Spout Projection:**  
1<sup>5</sup>/<sub>16</sub>" (24 mm)



**0397-1AC-41**  
EZ FILL™ WATER FAUCET

**0394-1AC-41**  
EZ FILL™ FOAM SOAP DISPENSER

**NO-TOUCH**  
DISPENSING

**VANITY**  
MOUNTED

Complete the look with the matching EZ Fill™ Water Faucet.

See all EZ Fill™ model options on page 59.

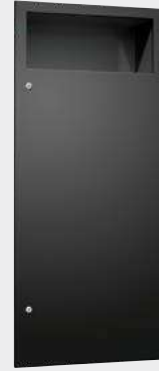

**6474-41PC**  
SIMPLICITY™ IN MATTE BLACK  
RECESSED WASTE RECEPTACLE

**12 gal.**  
WASTE CAPACITY  
(45.4 L)

**Model Option:**  
**6474-2-41PC** Semi-recessed with a matte black powder coated stainless steel collar.

**Unit Size:**  
17<sup>1</sup>/<sub>4</sub>" x 40" x 6<sup>3</sup>/<sub>4</sub>"  
(438 x 1016 x 171 mm)

**Wall Opening:**  
15<sup>3</sup>/<sub>4</sub>" x 38<sup>1</sup>/<sub>2</sub>" x 6<sup>1</sup>/<sub>4</sub>"  
(400 x 978 x 159 mm)



**0196-41**  
TURBO-PRO™ HIGH-SPEED  
ADA HAND DRYER

**<15 sec.**  
DRYING TIME

**68-73.8 dBA**  
NOISE LEVEL

**HEPA**  
FILTER

**Voltage:** 110-120 V (-1) and  
208-240 V (-2)

**Overall Dimensions:**  
8<sup>5</sup>/<sub>16</sub>" x 13<sup>9</sup>/<sub>16</sub>" x 4"  
(219 x 345 x 102 mm)

**Noise Level:** 68-73.8 dBA



**0199-1-41**  
ASI TURBO-ADA ACCESSIBILITY  
COMPLIANT HIGH-SPEED  
HAND DRYER

**<15 sec.**  
DRYING TIME

**68.9-74.3 dBA**  
NOISE LEVEL

**Overall Dimensions:**  
10<sup>5</sup>/<sub>16</sub>" x 8<sup>15</sup>/<sub>32</sub>" x 4"  
(270 x 215 x 102 mm)



**0600-41**  
INTER-LOK ANGLE FRAME MIRROR

**15 YEAR**  
WARRANTY

**Model Options:**  
**0600-1836-41** – 18" wide x 36" high  
(457 x 914 mm)  
**0600-2436-41** – 24" wide x 36" high  
(610 x 914 mm)  
**0600-2448-41** – 24" wide x 48" high  
(610 x 1219 mm)



**9014-41**  
**BABY CHANGING STATION, HORIZONTAL –**  
**MATTE BLACK, SURFACE MOUNTED**

≤250 lbs.

**Overall Dimensions:**

Closed: 35<sup>5</sup>/<sub>32</sub>" x 24<sup>1</sup>/<sub>4</sub>" x 3<sup>7</sup>/<sub>16</sub>"  
 (893 x 616 x 98 mm)      Open: 35<sup>5</sup>/<sub>32</sub>" x 24<sup>1</sup>/<sub>4</sub>" x 22<sup>1</sup>/<sub>32</sub>"  
 (893 x 616 x 560 mm)



**9018-41**  
**BABY CHANGING STATION, HORIZONTAL –**  
**MATTE BLACK, RECESSED**

≤250 lbs.

**Overall Dimensions:**

Closed: 35<sup>5</sup>/<sub>32</sub>" x 24<sup>1</sup>/<sub>4</sub>" x 3<sup>7</sup>/<sub>16</sub>"  
 (893 x 616 x 98 mm)      Open: 35<sup>5</sup>/<sub>32</sub>" x 24<sup>1</sup>/<sub>4</sub>" x 22<sup>1</sup>/<sub>32</sub>"  
 (893 x 616 x 560 mm)



**0864-41**  
**(30) NAPKIN/ (27) TAMPON VENDOR – MATTE BLACK,**  
**SURFACE MOUNTED – 25¢, 50¢ OR FREE OPERATION**

**27**  
 TAMPON  
 CAPACITY

**30**  
 NAPKIN  
 CAPACITY

**Overall Dimensions:**  
 11-3/4" x 26-1/8" x 6-1/2"  
 (298 x 663 x 165 mm)



**0839-41**  
**WASTE RECEPTACLE (19 GAL.) –**  
**MATTE BLACK, FREE STANDING**

**19 gal.**  
 WASTE CAPACITY  
 (72 L)

**FLOOR**  
 STANDING

**Overall Dimensions:**  
 12<sup>3</sup>/<sub>16</sub>" x 32" x 12<sup>1</sup>/<sub>2</sub>"  
 (314 x 800 x 318 mm)



**0030-41**  
**MATTE BLACK TOILET TISSUE DISPENSER,  
TWIN HIDE-A-ROLL – SURFACE MOUNTED**

**2**  
TOILET PAPER  
CAPACITY (ROLLS)

**Unit Size:**  
6" x 12" x 6½"  
(152 x 305 x 165 mm)



**0042-41**  
**JUMBO ROLL TOILET TISSUE DISPENSER**

**JUMBO**      **SURFACE**  
TOILET PAPER      MOUNTED  
CAPACITY (ROLLS)

**Overall Dimensions:**  
4⅝" x 10⅞" x 4¼"  
(118 x 262 x 113 mm)



**7305-41**  
**SINGLE TOILET TISSUE HOLDER**  
**7305-2-41**  
**DOUBLE TOILET TISSUE HOLDER**

**SURFACE**  
MOUNTED

**7304-41 Dimensions:**  
7¾" x 2" x 3⅞"  
(207 x 51 x 98 mm)

**7305-2-41 Dimensions:**  
13½" x 2" x 3⅞"  
(343 x 51 x 98 mm)



**3801-41**  
**STRAIGHT GRAB BAR**

**Model Options:**  
**3801-18-41** – 18" (457 mm)  
**3801-24-41** – 24" (610 mm)  
**3801-36-41** – 36" (914 mm)  
**3801-42-41** – 42" (1067 mm)



**0852-41**  
**SANITARY NAPKIN DISPOSAL –**  
**MATTE BLACK, SURFACE MOUNTED**

**1.2 gal.**  
WASTE CAPACITY  
(4.5 L)

**Overall Dimensions:**  
7<sup>7</sup>/<sub>8</sub>" x 9<sup>11</sup>/<sub>16</sub>" x 4"  
(200 x 246 x 102 mm)



**0477-SM-41**  
**MATTE BLACK SURFACE MOUNTED TOILET**  
**SEAT COVER DISPENSER**

**250** SINGLE  
OR HALF-FOLD  
PAPER SEAT  
COVERS

**Unit Size:**  
15<sup>3</sup>/<sub>4</sub>" x 11" x 1<sup>7</sup>/<sub>8</sub>"  
(400 x 279 x 48 mm)



**7340-41**  
**SINGLE ROBE HOOK**

**SURFACE**  
MOUNTED

**Unit Size:**  
2" x 2" x 2"  
(51 x 51 x 51 mm)



**7355-24-41**  
**ROUND TOWEL BAR – 24"**

**ROUND**  
STYLE

**Unit Size:**  
24" x 2" x 3<sup>1</sup>/<sub>4</sub>"  
(106 x 51 x 83 mm)



**7385-41**  
**TOWEL RING**

**Unit Size:**  
4<sup>1</sup>/<sub>2</sub>" x 5" x 2<sup>1</sup>/<sub>2</sub>"  
(114 x 127 x 64 mm)



# PAPER TOWEL DISPENSERS

Fundamental variety within a commercial washroom – from recessed, high capacity, and manual to wall mounted, exquisite, and automatic solutions.



**TRADITIONAL™  
SURFACE  
MOUNTED ROLL  
PAPER TOWEL  
DISPENSER**



**ROVAL™  
RECESSED  
PAPER TOWEL  
DISPENSER**



**TRADITIONAL™  
RECESSED  
PAPER TOWEL  
DISPENSER**



**0210**

**TRADITIONAL™ SURFACE MOUNTED  
PAPER TOWEL DISPENSER**

**525** MULTI-FOLD  
OR 400 C-FOLD  
PAPER TOWELS

**MANUAL  
DISPENSING**

**Model Option:**  
0210-41 Matte black.

**Unit Size:**  
11 1/8" x 14 5/8" x 4"  
(282 x 371 x 101 mm)



**20210**

**ROVAL™ SURFACE MOUNTED  
PAPER TOWEL DISPENSER**

**525** MULTI-FOLD  
OR 400 C-FOLD  
PAPER TOWELS

**MANUAL  
DISPENSING**

**Overall Dimensions:**  
11 1/16" x 13 9/16" x 4 7/8"  
(281 x 345 x 124 mm)



**6457**

**SIMPLICITY™ RECESSED PAPER TOWEL DISPENSER**

**475** MULTI-FOLD  
OR 350 C-FOLD  
PAPER TOWELS

**MANUAL  
DISPENSING**

**Unit Size:**  
12 3/4" x 17 1/4" x 4 1/2"  
(324 x 438 x 114 mm)

**Wall Opening:**  
11 1/4" x 15 3/4" x 4 1/4"  
(286 x 400 x 108 mm)



**6452**

**SIMPLICITY™ RECESSED PAPER TOWEL DISPENSER**

**800** MULTI-FOLD  
OR 600 C-FOLD  
PAPER TOWELS

**MANUAL  
DISPENSING**

**Model Option:**  
6452-9 Surface mounted with a stainless steel collar.

**Unit Size:**  
14 1/4" x 28" x 4 1/2"  
(362 x 711 x 114 mm)

**Wall Opening:**  
12 3/4" x 26 1/2" x 4 1/4"  
(324 x 673 x 108 mm)

## PAPER TOWEL DISPENSERS



**0457**  
TRADITIONAL™ RECESSED PAPER TOWEL DISPENSER

**500** MULTI-FOLD  
OR 350 C-FOLD  
PAPER TOWELS

**MANUAL**  
DISPENSING

**Model Options:**  
**0457-2** Semi-recessed.  
**0457-9** Surface mounted with a stainless steel collar.

**Unit Size:**  
12<sup>3</sup>/<sub>4</sub>" x 17<sup>1</sup>/<sub>4</sub>" x 4<sup>1</sup>/<sub>4</sub>"  
(324 x 438 x 108 mm)

**Wall Opening:**  
11<sup>1</sup>/<sub>4</sub>" x 15<sup>3</sup>/<sub>4</sub>" x 4"  
(286 x 400 x 102 mm)



**0452**  
TRADITIONAL™ RECESSED PAPER TOWEL DISPENSER

**800** MULTI-FOLD  
OR 600 C-FOLD  
PAPER TOWELS

**MANUAL**  
DISPENSING

**Model Option:**  
**0452-9** Surface mounted with a stainless steel collar.

**Unit Size:**  
14<sup>1</sup>/<sub>4</sub>" x 28" x 4<sup>1</sup>/<sub>4</sub>"  
(326 x 711 x 108 mm)

**Wall Opening:**  
12<sup>3</sup>/<sub>4</sub>" x 26<sup>1</sup>/<sub>2</sub>" x 4"  
(324 x 673 x 102 mm)



**6457-00**  
PIATTO™ COMPLETELY RECESSED PAPER TOWEL DISPENSER

**475** MULTI-FOLD  
OR 350 C-FOLD  
PAPER TOWELS

**MANUAL**  
DISPENSING

**Model Option:**  
**6457-41** Matte Black.

**Unit Size:**  
12<sup>3</sup>/<sub>4</sub>" x 17<sup>1</sup>/<sub>4</sub>" x 4<sup>9</sup>/<sub>16</sub>"  
(324 x 438 x 116 mm)

**Wall Opening:**  
12<sup>13</sup>/<sub>16</sub>" x 17<sup>9</sup>/<sub>16</sub>" x 4<sup>3</sup>/<sub>4</sub>"  
(325 x 440 x 121 mm)



**645210AC-41**  
PIATTO™ COMPLETELY RECESSED AUTOMATIC ROLL PAPER TOWEL DISPENSER

**UP TO 800 ft.**  
(244 M) LONG ROLL  
TOWEL CAPACITY

**NO-TOUCH**  
DISPENSING

**Model Option:**  
**645210AC-00** White.

**Unit Size:**  
16<sup>1</sup>/<sub>16</sub>" x 28" x 9<sup>13</sup>/<sub>16</sub>"  
(408 x 711 x 248 mm)

**Wall Opening:**  
16<sup>1</sup>/<sub>16</sub>" x 28<sup>1</sup>/<sub>16</sub>" x 10"  
(410 x 713 x 254 mm)



**645210A-41**

**PIATTO™ COMPLETELY RECESSED AUTOMATIC ROLL PAPER TOWEL DISPENSER**

**UP TO 800 ft.**  
(244 M) LONG ROLL  
TOWEL CAPACITY

**NO-TOUCH**  
DISPENSING

**Model Option:**  
**645210A-00** White.

**Unit Size:**  
16<sup>1</sup>/<sub>16</sub>" x 28" x 9<sup>13</sup>/<sub>16</sub>"  
(408 x 711 x 248 mm)

**Wall Opening:**  
16<sup>1</sup>/<sub>8</sub>" x 28<sup>1</sup>/<sub>16</sub>" x 10"  
(410 x 713 x 254 mm)



**20452**

**ROVAL™ RECESSED PAPER TOWEL DISPENSER**

**800** MULTI-FOLD  
OR 600 C-FOLD  
PAPER TOWELS

**MANUAL**  
DISPENSING

**Overall Dimensions:**  
12<sup>3</sup>/<sub>4</sub>" x 28" x 5<sup>7</sup>/<sub>16</sub>"  
(324 x 711 x 137 mm)

**Wall Opening:**  
11<sup>1</sup>/<sub>4</sub>" x 26<sup>7</sup>/<sub>16</sub>" x 3<sup>15</sup>/<sub>16</sub>"  
(286 x 672 x 100 mm)



**68523A**

**SIMPLICITY™ AUTOMATIC ROLL TOWEL DISPENSER**

**UP TO 800 ft.**  
(244 M) LONG ROLL  
TOWEL CAPACITY

**NO-TOUCH**  
DISPENSING

**SUFFIX OPTIONS FOR POWER/MOUNTING:**  
[A, A-4, AC, AC-4]

**A:** Powered by 4 D-size batteries (not included).  
**AC:** Powered by AC plug-in adapter.  
**-4:** Semi-recessed stainless steel.

**Overall Dimensions:**  
15<sup>1</sup>/<sub>4</sub>" x 18<sup>5</sup>/<sub>16</sub>" x 9<sup>13</sup>/<sub>16</sub>"  
(387 x 465 x 249 mm)



**645210A**

**SIMPLICITY™ AUTOMATIC ROLL PAPER TOWEL DISPENSER**

**UP TO 800 ft.**  
(244 M) LONG ROLL  
TOWEL CAPACITY

**NO-TOUCH**  
DISPENSING

**SUFFIX OPTIONS FOR POWER/MOUNTING:**  
[A, A-6, A-9, AC, AC-6, AC-9]

**A:** Powered by 4 D-size batteries (not included).  
**AC:** Powered by AC plug-in adapter.  
**-6:** Semi-recessed with a stainless steel collar.  
**-9:** Surface mounted with a stainless steel collar.

**Unit Size:**  
16<sup>1</sup>/<sub>16</sub>" x 28" x 9<sup>1</sup>/<sub>2</sub>"  
(408 x 711 x 241 mm)

**Wall Opening:**  
14<sup>1</sup>/<sub>2</sub>" x 26<sup>1</sup>/<sub>2</sub>" x 9<sup>1</sup>/<sub>4</sub>"  
(368 x 673 x 235 mm)



**645224A**  
**SIMPLICITY™ AUTOMATIC ROLL PAPER TOWEL DISPENSER**

**UP TO 800 ft.**  
 (244 M) LONG ROLL  
 TOWEL CAPACITY

**NO-TOUCH**  
 DISPENSING

**SUFFIX OPTIONS FOR POWER/MOUNTING:**  
 [A, A-6, AC, AC-6, AC-9]

**AC:** Powered by AC plug-in adapter.  
**-9:** Surface mounted with a stainless steel collar.

**Unit Size:**  
 17¼" x 30½" x 10¼"  
 (438 x 775 x 260 mm)

**Wall Opening:**  
 15¾" x 29" x 4"  
 (400 x 737 x 102 mm)



**8524**  
**SPRING LOADED NO-TOUCH SURFACE MOUNTED ROLL PAPER TOWEL DISPENSER**

**UP TO 800 ft.**  
 (244 M) LONG ROLL  
 TOWEL CAPACITY

**NO-TOUCH**  
 DISPENSING

**Model Options:**  
**8523A** Auto roll towel dispenser, surface mounted.  
**8523AC** Auto roll towel dispenser, 110-240 VAC, surface mounted.

**Unit Size:**  
 12" x 16" x 9"  
 (305 x 406 x 228 mm)



**045210A**  
**TRADITIONAL™ AUTOMATIC RECESSED ROLL PAPER TOWEL DISPENSER**

**UP TO 800 ft.**  
 (244 M) LONG ROLL  
 TOWEL CAPACITY

**NO-TOUCH**  
 DISPENSING

**SUFFIX OPTIONS FOR POWER/MOUNTING:**  
 [A, A-6, A-9, AC, AC-6, AC-9]

**A:** Powered by 4 D-size batteries (not included).  
**AC:** Powered by AC plug-in adapter.  
**-6:** Semi-recessed with a stainless steel collar.  
**-9:** Surface mounted with a stainless steel collar.

**Unit Size:**  
 17¼" x 28" x 10"  
 (438 x 711 x 254 mm)

**Wall Opening:**  
 15¾" x 26½" x 10¼"  
 (400 x 673 x 260 mm)



**204523A**  
**ROVAL™ AUTOMATIC RECESSED ROLL PAPER TOWEL DISPENSER**

**UP TO 800 ft.**  
 (244 M) LONG ROLL  
 TOWEL CAPACITY

**NO-TOUCH**  
 DISPENSING

**SUFFIX OPTIONS FOR POWER/MOUNTING:**  
 [A, A-6, A-9, AC, AC-6, AC-9]

**A:** Powered by 4 D-size batteries (not included).  
**AC:** Powered by AC plug-in adapter.  
**-6:** Semi-recessed with a stainless steel collar.  
**-9:** Surface mounted with a stainless steel collar.

**Unit Size:**  
 17⅜" x 27¾" x 11⅛"  
 (441 x 705 x 297 mm)

**Wall Opening:**  
 15¾" x 26" x 10"  
 (400 x 660 x 254 mm)



**1005**  
**VANITY TOP PAPER TOWEL HOLDER**

**350** MULTI-FOLD  
 OR 250 C-FOLD  
 PAPER TOWELS

**MANUAL**  
 DISPENSING

**COUNTER**  
 POSITIONED

**Overall Dimensions:**  
 11" x 7½" x 5½"  
 (279 x 191 x 140 mm)



**1002**  
**TRADITIONAL™ COUNTER TOP MOUNTED  
 PAPER TOWEL DISPENSER**

**UP TO 300**  
 MULTI-FOLD  
 PAPER TOWELS

**MANUAL**  
 DISPENSING

**COUNTER**  
 MOUNTED

**Unit Size:**  
 14¼" x 6" x ¾"  
 (362 x 152 x 2 mm)

**Counter Opening:**  
 12½" x 4¼"  
 (318 x 108 mm)



**0215**  
**TRADITIONAL™ SURFACE MOUNTED  
 PAPER TOWEL DISPENSER – PETITE**

**275** MULTI-FOLD  
 OR 200 C-FOLD  
 PAPER TOWELS

**MANUAL**  
 DISPENSING

**Overall Dimensions:**  
 11" x 8" x 4"  
 (279 x 203 x 102 mm)



**0245-SS**  
**TRADITIONAL™ SURFACE MOUNTED  
 PAPER TOWEL DISPENSER**

**400**  
 SINGLE-FOLD  
 PAPER TOWELS

**MANUAL**  
 DISPENSING

**Overall Dimensions:**  
 11¼" x 6¼" x 5⅝"  
 (285 x 160 x 143 mm)



**0439**

**TRADITIONAL™ PAPER TOWEL DISPENSER FOR BEHIND THE MIRROR**

**800** MULTI-FOLD  
OR 600 C-FOLD  
PAPER TOWELS

**MANUAL**  
DISPENSING

**FOR BEHIND**  
THE MIRROR

**Overall Dimensions:**  
11½" x 18" x 4½"  
(292 x 457 x 108 mm)



**8522**

**TRADITIONAL™ SURFACE MOUNTED ROLL PAPER TOWEL DISPENSER**

**UP TO 800 ft.**  
(244 M) LONG ROLL  
TOWEL CAPACITY

**MANUAL**  
DISPENSING

**Model Options:**  
**8523A** Powered by 4 D-size batteries (not included).  
**8523AC** Powered by AC plug-in adapter.

**Overall Dimensions:**  
14" x 16" x 9½"  
(356 x 406 x 241 mm)



**8165**

**TRADITIONAL™ SURFACE MOUNTED ROLL PAPER TOWEL DISPENSER**

**1**  
PAPER TOWEL  
ROLL CAPACITY

**MANUAL**  
DISPENSING

**Overall Dimensions:**  
Unit measures 13" (330 mm) wide;  
projects 6" (152 mm) from wall.



**8374**

**AUTOMATIC ROLL TOWEL DISPENSER MECHANISM**

**UP TO 800 ft.**  
(244 M) LONG ROLL  
TOWEL CAPACITY

**NO-TOUCH**  
DISPENSING

**SPARE**  
PART

**Model Option:**  
**8370** Manual lever operated.

**Overall Dimensions:**  
12<sup>5</sup>/<sub>16</sub>" x 15<sup>1</sup>/<sub>16</sub>" x 8<sup>11</sup>/<sub>16</sub>"  
(313 x 383 x 221 mm)



PIC SHOWS MODEL 0391



PIC SHOWS MODEL 0334-S

## SOAP DISPENSING SYSTEMS SOLUTIONS DETAIL



**A VARIETY OF DESIGNS FOR SOAP, FOAM, AND SANITIZER.**

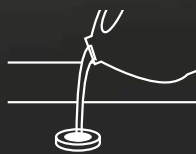

**12 DISPENSERS — SINGLE REFILL**

Single Soap Reservoir of 1.5gal/6L serves up to 12 soap- or foam-dispensers via convenient Top-Fill-Port in the counter.









**UNIVERSAL REMOTE**

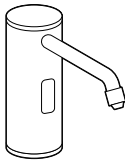
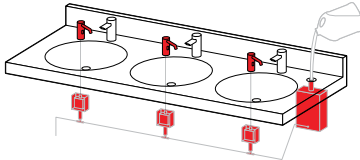









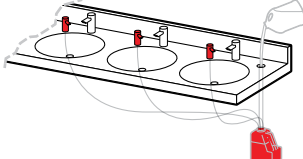

Controls all dispensers with one remote, allowing flexibility in settings with a choice of 4 presets.





# SOAP, FOAM, AND SANITIZER DISPENSERS + MATCHING FAUCETS

## TOP FILL MULTI-FEED SOAP DISPENSING SYSTEM

0388 & 0389 TOP FILL MULTI-FEED SYSTEM (UP TO 12*)					
					
Soap Heads	Model		Soap Heads	Model	
 LIQUID	0387	Top Fill, Multi-Feed – Vanity Mounted Fill Port w/ 6L Under Vanity Tank	 FOAM	0387	Top Fill, Multi-Feed – Vanity Mounted Fill Port w/ 6L Under Vanity Tank
	 0388-1A	Top Fill, Multi-Feed Liquid Soap Dispenser (Batt. not incl.) Satin Finish		 0389-1A	Top Fill, Multi-Feed Foam Soap Dispenser (Batt. not incl.) Satin Finish
	 0388-1AC	Top Fill, Multi-Feed Liquid Soap Dispenser (AC) Satin Finish		 0389-1AC	Top Fill, Multi-Feed Foam Soap Dispenser (AC) Satin Finish

\*Max 6 dispensers on each side of tank. For proper installation refer to owner's manual.

EZ FILL™ INDIVIDUAL					EZ FILL™ MULTI-FEED SYSTEM (UP TO 6)				
					Refill up to six soap dispensers with one pour.				
Individual vanity mounted automatic soap dispenser is refilled by removing 1 liter bottle from EZ FILL™ bracket under the counter.									
Soap Heads	Individual Chrome	6 Pack SKU <sup>1</sup>	Individual Matte Black	6 Pack SKU <sup>1</sup>	Soap Heads	Multi-Feed Chrome	6 Pack SKU <sup>1</sup>	Multi-Feed Matte Black	6 Pack SKU <sup>1</sup>
 LIQUID	 0391-1AC	0391-6-1AC	0391-1AC-41	0391-6-1AC-41	 LIQUID	 0390-1AC	0390-6-1AC	0390-1AC-41	0390-6-1AC-41
	 0391-1A	0391-6-1A	0391-1A-41	0391-6-1A-41		 0390-1A	0390-6-1A	0390-1A-41	0390-6-1A-41
 FOAM	 0394-1AC	0394-6-1AC	0394-1AC-41	0394-6-1AC-41	 FOAM	 0393-1AC	0393-6-1AC	0393-1AC-41	0393-6-1AC-41
	 0394-1A	0394-6-1A	0394-1A-41	0394-6-1A-41		 0393-1A	0393-6-1A	0393-1A-41	0393-6-1A-41

Faucets	
CHROME	 0397-1AC
	 0397-1A
MATTE BLACK	 0397-1AC-41
	 0397-1A-41

### TOP FILL, MULTI-FEED SYSTEM REQUIRES (A) AND (B)

(A) 0390 - Multi-Feed Kit<sup>2</sup> – Kit<sup>2</sup> includes a 6 Liter Soap Container, Top Fill Tube and Counter Fill Port with Cover (B) Multi-Feed – Soap Dispenser Head(s)<sup>4</sup>

### EZ FILL™ ACCESSORIES

0390-BR- Optional Under Counter Mounting Bracket for 6 Liter Container  
0390-R- Remote Control<sup>1</sup> to adjust liquid dispensing settings

0390-ARK- Anti-Rotation Kit for all 0390 Series  
0393-R- Remote Control<sup>1</sup> to adjust foam dispensing settings

*Stand Alone Dispensers come standard with 1 Liter soap container*

<sup>1</sup> One Remote Control provided at no charge, with the 6 Pack SKU  
<sup>2</sup> Powered by 6 D-size batteries (not included)

<sup>3</sup> Kit does not include soap dispenser heads  
<sup>4</sup> Soap Dispenser Heads do not come with Multi-Feed Kit



**0391-(N)**  
**AUTOMATIC VANITY MOUNTED LIQUID SOAP AND  
 GEL HAND SANITIZER DISPENSER – CHROME**

**33.8 oz.**    **NO-TOUCH**    **BATTERY**  
 CAPACITY    DISPENSING    POWERED

**Model Options:**  
 0391-(N)-41 Matte Black.  
 0390-(N) Multi-Feed Soap Dispenser.  
 0393-(N) Multi-Feed Foam Soap Dispenser.  
 0394-(N) Stand-Alone Foam Soap Dispenser.

**SUFFIX OPTIONS FOR POWER:**  
 [1A, 1AC, 6-1A, 6-1AC]

1A: Powered by 6 D-size batteries (not included).  
 1AC: Powered by AC plug-in adapter.  
 6-1A: Powered by 6 D-size batteries (not included).  
 6-1AC: Powered by AC plug-in adapter.



**0397**  
**EZ FILL™ WATER FAUCET – CHROME**

**202.8 oz.**    **NO-TOUCH**  
 CAPACITY    DISPENSING

**Model Option:**  
 0397-1AC-41 Matte Black.

**SUFFIX OPTIONS FOR POWER:**  
 [1A, 1A-41, 1AC, 1AC-41]

1A: Chrome, battery powered.  
 1A-41: Matte Black, battery powered.  
 1AC: Chrome, AC powered.  
 1AC-41: Matte Black, AC powered.

**0390 EZ FILL™**  
**TOP FILL MULTI-FEED KIT**  
**FOR 0390-(N) & 0393-(N)**

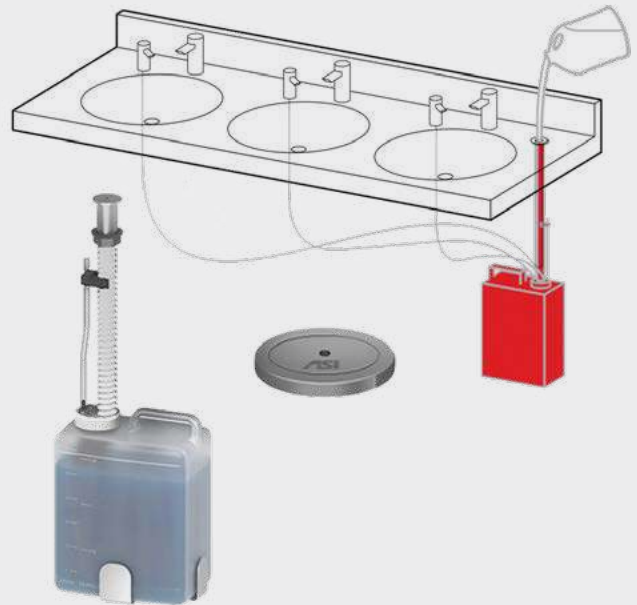



**0334-S**  
**AUTOMATIC VANITY MOUNTED LIQUID SOAP AND GEL HAND SANITIZER DISPENSER – SATIN FINISH**

**50.7 oz.**    **NO-TOUCH**    **BATTERY**  
 CAPACITY    DISPENSING    POWERED

**Model Option:**  
**0334-B** Stainless steel with bright finish.

**Unit Size:**  
 1½" x 3¼" (38 x 97 mm)  
 (dispenser body only)

**Spout Projection:**  
 3⁄8" (98 mm)



**0335-B**  
**AUTOMATIC VANITY MOUNTED FOAM SOAP AND HAND SANITIZER DISPENSER – BRIGHT POLISHED FINISH**

**50.7 oz.**    **NO-TOUCH**    **BATTERY**  
 CAPACITY    DISPENSING    POWERED

**Model Option:**  
**0335-S** Stainless steel with satin finish.

**Unit Size:**  
 1½" x 3¼" (38 x 97 mm)  
 (dispenser body only)

**Spout Projection:**  
 3⁄8" (98 mm)

**0387**  
**TOP FILL PORT WITH MULTI-FEED TANK FOR 0388 & 0389**

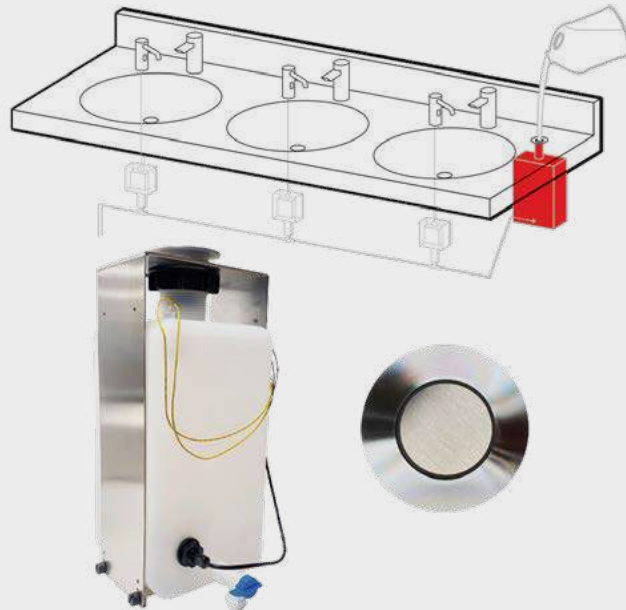



**0362-41**  
**AUTOMATIC SURFACE MOUNTED LIQUID SOAP AND GEL HAND SANITIZER DISPENSER - MATTE BLACK**

---

**28 oz.**  
CAPACITY

**NO-TOUCH**  
DISPENSING

**BATTERY**  
POWERED

**Model Option:**  
**0362 Satin.**

**Overall Dimensions:**  
 4<sup>13</sup>/<sub>16</sub>" x 10<sup>5</sup>/<sub>16</sub>" x 4<sup>1</sup>/<sub>8</sub>"  
 (122 x 270 x 105 mm)



**0360**  
**AUTOMATIC SURFACE MOUNTED LIQUID SOAP AND GEL HAND SANITIZER DISPENSER**

---

**35 oz.**  
CAPACITY

**NO-TOUCH**  
DISPENSING

**BATTERY**  
POWERED

**Overall Dimensions:**  
 4<sup>17</sup>/<sub>32</sub>" x 9<sup>1</sup>/<sub>4</sub>" x 4<sup>7</sup>/<sub>8</sub>"  
 (115 x 235 x 124 mm)



**20364**  
**ROVAL™ AUTOMATIC SURFACE MOUNTED LIQUID SOAP AND GEL HAND SANITIZER DISPENSER**

---

**34 oz.**  
CAPACITY

**NO-TOUCH**  
DISPENSING

**Model Options:**  
**20363** Liquid soap dispenser.  
**20365** Foam soap and hand sanitizer.

**Overall Dimensions:**  
 5<sup>1</sup>/<sub>2</sub>" x 10<sup>7</sup>/<sub>8</sub>" x 4"  
 (140 x 276 x 102 mm)



**0361**  
**AUTOMATIC SURFACE MOUNTED LIQUID SOAP AND GEL HAND SANITIZER DISPENSER**

---

**27 oz.**  
CAPACITY

**BATTERY**  
POWERED

**NO-TOUCH**  
DISPENSING

**Overall Dimensions:**  
 4<sup>5</sup>/<sub>8</sub>" x 10<sup>9</sup>/<sub>16</sub>" x 4<sup>1</sup>/<sub>16</sub>"  
 (118 x 262 x 113 mm)

 = LIQUID     = FOAM

 Products with this icon can dispense hand sanitizer.



**0338**  
TOP FILL AUTOMATIC VANITY MOUNTED LIQUID SOAP DISPENSER

**50.7 oz.** **NO-TOUCH** **VANITY**  
CAPACITY DISPENSING MOUNTED

**Model Option:**  
**0339** Foam soap dispenser.

**Unit Size:**  
1½" x 5¾" (38 x 137 mm)  
(dispenser body only)

**Spout Projection:**  
3¾" (98 mm)



**20334**  
AUTOMATIC VANITY MOUNTED FOAM SOAP DISPENSER

**54 oz.** **CHROME** **NO-TOUCH** **VANITY**  
CAPACITY PLATED BRASS DISPENSING MOUNTED

**Model Option:**  
**20333** Liquid soap dispenser.

**Overall Dimensions:**  
6¾" x 16"  
(172 x 407 mm)

**Spout Projection:**  
3¾" (99 mm)



**0332**  
VANITY MOUNTED MANUAL LIQUID SOAP DISPENSER

**34 oz.** **CHROME** **MANUAL** **VANITY**  
CAPACITY PLATED BRASS DISPENSING MOUNTED

**Model Options:**

	Capacity	Spout
0332	34 oz. (1.0 L)	4" (102 mm)
0332-C	20 oz. (0.6 L)	4" (102 mm)
0332-CD	20 oz. (0.6 L)	6" (152 mm)
0332-D	34 oz. (1.0 L)	6" (152 mm)

**Unit Size:**  
3⅞" x 10<sup>2</sup>/<sub>32</sub>"  
(87 x 271 mm)



**0336**  
VANITY MOUNTED MANUAL FOAM SOAP DISPENSER

**34 oz.** **MANUAL** **VANITY**  
CAPACITY DISPENSING MOUNTED

**Unit Size:**  
3½" x 15¾"  
(87 x 271 mm)

**Spout Projection:**  
4" (102 mm)



**5001-SS**  
**DISPOSA-VALVE SURFACE MOUNTED LIQUID SOAP DISPENSER**

**MANUAL**  
DISPENSING

**Overall Dimensions:**  
4¼" x 11" x 4"  
(108 x 279 x 102 mm)



**0341**  
**SURFACE MOUNTED PLASTIC LIQUID AND ANTISEPTIC SOAP DISPENSER**

**40.5 oz.**      **MANUAL**  
CAPACITY      DISPENSING

**Overall Dimensions:**  
5⅞" x 9⅝" x 4½"  
(138 x 233 x 102 mm)



**0326**  
**RECESSED HORIZONTAL LIQUID SOAP DISPENSER**

**57 oz.**  
CAPACITY

**Unit Size:**  
10¼" x 6" x 4½"  
(260 x 152 x 115 mm)

**Wall Opening:**  
9" x 4⅞" x 4"  
(229 x 124 x 102 mm)

**Spout Projection:**  
2½" (64 mm)



**9343**  
**PROFILE™ SURFACE MOUNTED LIQUID SOAP DISPENSER**

**48 oz.**  
CAPACITY

**Model Option:**  
**9343-41 Matte Black.**

**Overall Dimensions:**  
7¼" x 6½" x 3⅛"  
(184 x 165 x 94 mm)

**Spout Projection:**  
1⅝" (24 mm)





**0347**  
SURFACED MOUNTED VERTICAL  
LIQUID SOAP DISPENSER

**0345**  
SURFACED MOUNTED HORIZONTAL  
LIQUID SOAP DISPENSER

**40 OZ.**  
CAPACITY      **MANUAL**  
DISPENSING

**Model Options:**  
**0347-41** Matte Black.  
**0345-41** Matte Black.

**0347 Unit Size:**  
4<sup>13</sup>/<sub>16</sub>" x 8<sup>7</sup>/<sub>16</sub>" x 3<sup>15</sup>/<sub>16</sub>"  
(122 x 208 x 100 mm)

**0345 Unit Size:**  
8<sup>3</sup>/<sub>16</sub>" x 4<sup>13</sup>/<sub>16</sub>" x 3<sup>15</sup>/<sub>16</sub>"  
(208 x 122 x 100 mm)

**Spout Projection:**  
1<sup>1</sup>/<sub>2</sub>" (38 mm)



**0357**  
SURFACED MOUNTED  
HORIZONTAL FOAM SOAP DISPENSER

**0359**  
SURFACED MOUNTED VERTICAL  
FOAM SOAP DISPENSER

**40 OZ.**  
CAPACITY      **MANUAL**  
DISPENSING

**0357 Unit Size:**  
8<sup>3</sup>/<sub>16</sub>" x 4<sup>13</sup>/<sub>16</sub>" x 4<sup>1</sup>/<sub>2</sub>"  
(208 x 122 x 114 mm)

**0359 Unit Size:**  
4<sup>13</sup>/<sub>16</sub>" x 8<sup>3</sup>/<sub>16</sub>" x 4<sup>1</sup>/<sub>2</sub>"  
(122 x 208 x 114 mm)

**Spout Projection:**  
1<sup>1</sup>/<sub>2</sub>" (38 mm)



# WASTE RECEPTACLES

A wide range of waste receptacles, from fully recessed, semi-recessed, surface mounted, and counter mounted to freestanding with fully removable waste cans.

**WASTE RECEPTACLES**  
**ALL STAINLESS STEEL IS TYPE 304 WITH SATIN FINISH,**  
**UNLESS OTHERWISE NOTED.**



**COVERED  
WASTE  
RECEPTACLES**



**COUNTER  
TOP  
WASTE  
RECEPTACLES**



**RECESSED  
WASTE  
RECEPTACLES**



**1000**  
TRADITIONAL™ CIRCULAR  
COUNTER TOP WASTE CHUTE

**6" COUNTER**  
DIAMETER MOUNTED

**Model Option:**  
**1000A** has a 9" (229 mm) outside diameter with a counter opening of 8 1/8" (206 mm) diameter.

**Unit Size:**  
6 3/4" (171 mm)  
outside diameter

**Counter Opening:**  
5 3/4" (146 mm) diameter



**1003**  
TRADITIONAL™ COUNTER TOP  
MOUNTED WASTE RECEPTACLE

**7.4 gal. COUNTER**  
WASTE CAPACITY MOUNTED  
(28 L)

**Unit Size:**  
14 1/4" x 10" x 3/32"  
(362 x 254 x 2 mm)

**Counter Opening:**  
8 3/4" x 12 1/2"  
(222 x 318 mm)



**0815**  
FLOOR STANDING FOOT  
OPERATED WASTE RECEPTACLE

**8 gal.**  
WASTE CAPACITY  
(30.7 L)

**Overall Dimensions:**  
10 3/4" x 20 1/16" x 10"  
(273 x 531 x 254 mm)



**0834-RB**  
FREESTANDING 3-BIN  
RECYCLING STATION

**42 gal.**  
WASTE CAPACITY  
(159 L)

**Model Option:**  
**0839-RB** has 57 gal. (216 L) capacity with 37 1/8" x 31 7/8" x 12 1/2" (943 x 810 x 318 mm).

**Overall Dimensions:**  
37 1/8" x 31 7/8" x 12 1/2"  
(943 x 810 x 318 mm)



**0834**  
TRADITIONAL™ FREESTANDING  
WASTE RECEPTACLE

**14 gal.**  
WASTE CAPACITY  
(54 L)

**Model Option:**  
**0839** has 19 gal. (72 L) capacity with 12 3/8" x 32" x 12 1/2" (314 x 800 x 318 mm) dimensions.

**Overall Dimensions:**  
12 3/8" x 24" x 12 1/2"  
(314 x 609 x 318 mm)



**0834-T**  
TRADITIONAL™ FREESTANDING  
WASTE RECEPTACLE WITH DUAL  
SWING TOP

**14 gal.**  
WASTE CAPACITY  
(54 L)

**Model Option:**  
**0839-T** has 19 gal. (72 L) capacity with 12 3/8" x 37 1/4" x 12 1/2" (314 x 946 x 318 mm) dimensions.

**Overall Dimensions:**  
12 3/8" x 29 3/4" x 12 1/2"  
(314 x 756 x 318 mm)



**0458**  
**TRADITIONAL™ SEMI-RECESSED WASTE RECEPTACLE**

**12 gal.**

WASTE CAPACITY  
(46 L)

**Model Option:**  
**0458-9** Surface mounted with a stainless steel collar.

**Unit Size:**

17¼" x 30½" x 8¼"  
(438 x 775 x 210 mm)

**Wall Opening:**

15¼" x 29" x (variable\*)  
(400 x 737 mm)

\*[0458 if 4" (102 mm) x 4" and 12 gals. (46 L); 0458-CX if ½" (13 mm) x 7½" (191 mm) and 12 gals. (46 L); 0458-DX if 8" (203 mm) x 4" (102 mm) and 18 gals. (68 L)]



**7317**  
**COVERED WASTE RECEPTACLE – BRIGHT POLISHED FINISH**

**2.0 gal.**

WASTE CAPACITY  
(7.6 L)

**FLOOR**

STANDING

**Model Option:**  
**7317-S** Satin stainless steel finish.

**Overall Dimensions:**

8½" DIA x 12¾"  
(210 DIA x 324 mm)



**0829**  
**CORNER WASTE RECEPTACLE**

**16 gal.**

WASTE CAPACITY  
(60 L)

**CORNER-SURFACE**  
**MOUNTED**

**Overall Dimensions:**

15" x 23" x 14½"  
(381 x 584 x 368 mm)



**20826**  
**ROVAL™ SURFACE MOUNTED WASTE RECEPTACLE**

**12.8 gal.**

WASTE CAPACITY  
(48.4 L)

**Model Option:**  
**20826-T** Closed top, spring-loaded door. Capacity 12.8 gal. (48.4 L).

**Overall Dimensions:**

15⅝" x 23" x 8½"  
(384 x 584 x 216 mm)



**20458**  
**ROVAL™ SEMI-RECESSED REMOVABLE  
WASTE RECEPTACLE**

**11.2 gal.**

**WASTE CAPACITY**  
(42.6 L)

**Unit Size:**  
17<sup>5</sup>/<sub>8</sub>" x 27<sup>3</sup>/<sub>4</sub>" x 8<sup>15</sup>/<sub>16</sub>"  
(441 x 705 x 227 mm)

**Wall Opening:**  
15<sup>3</sup>/<sub>4</sub>" x 26" x 3<sup>15</sup>/<sub>16</sub>"  
(400 x 660 x 100 mm)



**0825**  
**TRADITIONAL™ SURFACE MOUNTED WASTE RECEPTACLE**

**17 gal.**

**WASTE CAPACITY**  
(64 L)

**Model Option:**  
**0826** has 12 gal. (45.4 L) capacity with  
15<sup>1</sup>/<sub>4</sub>" x 23" x 8" (387 x 584 x 203 mm) dimensions.

**Overall Dimensions:**  
15<sup>3</sup>/<sub>4</sub>" x 21<sup>1</sup>/<sub>2</sub>" x 11<sup>3</sup>/<sub>4</sub>"  
(400 x 556 x 298 mm)



**0827**  
**TRADITIONAL™ SURFACE MOUNTED  
WASTE RECEPTACLE**

**2 gal.**

**WASTE CAPACITY**  
(7.6 L)

**Overall Dimensions:**  
10<sup>1</sup>/<sub>2</sub>" x 9" x 4<sup>3</sup>/<sub>4</sub>"  
(267 x 229 x 121 mm)



**0828**  
**TRADITIONAL™ SURFACE MOUNTED  
WASTE RECEPTACLE**

**6.5 gal.**

**WASTE CAPACITY**  
(24.8 L)

**Overall Dimensions:**  
14" x 18" x 6"  
(356 x 457 x 152 mm)



**6474**

**SIMPLICITY™ RECESSED WASTE RECEPTACLE**

**12 gal.**

**WASTE CAPACITY**  
(45.4 L)

**Model Options:**

- 6474-41PC** Matte Black
- 6474-2** Semi-recessed with a stainless steel collar.
- 6474-2-41PC** Matte Black.

**Unit Size:**

17¼" x 40" x 6¾"  
(438 x 1016 x 171 mm)

**Wall Opening:**

15¾" x 38½" x 6¼"  
(400 x 978 x 159 mm)



**6474-00**

**PIATTO™ RECESSED WASTE RECEPTACLE**

**12 gal.**

**WASTE CAPACITY**  
(46 L)

**CONCEALED**

**LOCKING MECHANISM**

**Unit Size:**

17¼" x 40" x 6⅞"  
(438 x 1016 x 166 mm)

**Finished Wall Opening\*:**

17⅞" x 40⅞" x 6⅞"  
(440 x 1018 x 170 mm)



**04733**

**TRADITIONAL™ RECESSED WASTE RECEPTACLE**

**3 gal.**

**WASTE CAPACITY**  
(11.4 L)

**Unit Size:**

14¼" x 28" x 4½"  
(362 x 711 x 114 mm)

**Wall Opening:**

12¾" x 26½" x 4"  
(324 x 673 x 102 mm)



**6459**

**SIMPLICITY™ RECESSED WASTE RECEPTACLE**

**4 gal.**

**WASTE CAPACITY**  
(15.0 L)

**Unit Size:**

14¼" x 28" x 4½"  
(362 x 711 x 114 mm)

**Wall Opening:**

12¾" x 26½" x 4¼"  
(324 x 673 x 108 mm)



**TURBO-PRO™ DETAILS**

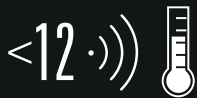

**ADJUSTABLE AND FAST**

Speed, noise, and temperature are adjustable.



**HEPA FILTER**

A HEPA filter is used to purify the air before it dries hands.



**STAINLESS STEEL CONSTRUCTION**

Our hand dryers are constructed of stainless steel, which is tough, durable, stain-resistant, and easy to clean.



**ADA ACCESSIBILITY STANDARD COMPLIANT**

Our hand dryers are engineered to comply with the standards set forth by the Americans with Disabilities Act for accessibility and safety.

# AUTOMATIC HAND DRYERS

Elegant and functional dryer range—from HEPA filtered High Speed Models (less than 10 sec.) to very quiet Icons (less than 66 dBA)—most of them with adjustable settings (air-speed and temperature).

## FEATURES

- Fast drying
- Quiet
- Ultra-hygienic – HEPA filter
- ADA compliant – ultra slim

## VARIABLE SETTINGS

- Noise (Airflow)
- Heat
- Energy Efficiency

## NOISE LEVEL

68 to 73.8 dBA

## DIMENSIONS

8<sup>5</sup>/<sub>8</sub>" x 13<sup>3</sup>/<sub>16</sub>" x 4"  
(219 x 345 x 102 mm)

## ELECTRIC

Different models for operating voltage

110-120 V (50/60 Hz),

220-240 V (50/60 Hz)

ON/OFF Heat Option

Nichrome Wire

325 – 500 W



**0192-1-93**  
**TURBO SWIFT™ ADA HIGH-SPEED HAND DRYER**

**<12 sec.**  
DRYING TIME

**74 dBA**  
NOISE LEVEL

**Voltage:** 110-120 V

**Model Option:**  
**0192-1-41** Matte Black.  
**0192-2-93** Satin Stainless Steel.

**Overall Dimensions:**  
6<sup>27</sup>/<sub>32</sub>" x 10<sup>1</sup>/<sub>16</sub>" x 4"  
(174 x 256 x 102 mm)



**0196-1-41**  
**TURBO-PRO™ HIGH-SPEED ADA HAND DRYER**

**<15 sec.**  
DRYING TIME

**68-73.8 dBA**  
NOISE LEVEL

**HEPA**  
FILTER

**Voltage:** 110-120 V (-1) and 208-240 V (-2)

**Model Option:**  
**0196-1-00** White.  
**0196-1-93** Satin Stainless Steel.  
**0196-2-00** White.  
**0196-2-41** Matte Black.  
**0196-2-93** Satin Stainless Steel.

**Overall Dimensions:**  
8<sup>5</sup>/<sub>8</sub>" x 13<sup>3</sup>/<sub>16</sub>" x 4"  
(219 x 345 x 102 mm)



**0197-2-93**  
**TURBO-DRI™ HIGH-SPEED STAINLESS STEEL**  
**HAND DRYER**

**<15 sec.**  
DRYING TIME

**61.2-65.2 dBA**  
NOISE LEVEL

**Voltage:** 115-120 V (-1) and 208-240 V (-2)  
**Auto Shut Off:** 60 seconds

**Overall Dimensions:**  
8<sup>1</sup>/<sub>16</sub>" x 11<sup>13</sup>/<sub>64</sub>" x 7<sup>5</sup>/<sub>64</sub>"  
(205 x 287 x 180 mm)



**0199-1-41**  
**ASITURBO-ADA ACCESSIBILITY COMPLIANT**  
**HIGH-SPEED HAND DRYER**

**<15 sec.**  
DRYING TIME

**68.9-74.3 dBA**  
NOISE LEVEL

**Voltage:** 110-120 V (-1) and 208-240 V (-2)  
**Auto Shut Off:** 60 seconds

**Model Option:**  
**0199-1-00** White.  
**0199-1-93** Satin Stainless Steel.  
**0199-2-00** White.  
**0199-2-41** Matte Black.  
**0199-2-93** Satin Stainless Steel.

**Overall Dimensions:**  
10<sup>5</sup>/<sub>8</sub>" x 8<sup>15</sup>/<sub>32</sub>" x 4"  
(270 x 215 x 102 mm)





**0185**  
**PROFILE™ HAND DRYER**

**<25 sec.**  
DRYING TIME

**69.2 dBA**  
NOISE LEVEL

**Voltage:** Automatically adjusts to voltages of 100-240 V

**Model Option:**

- 0184** Surface mounted no-touch hand dryer, 277 V.
- 0185-92** Bright Stainless Steel.
- 0185-00** White.
- 0185-93** Satin Stainless Steel.

**Overall Dimensions:**

14<sup>7</sup>/<sub>16</sub>" x 10<sup>13</sup>/<sub>16</sub>" x 3<sup>15</sup>/<sub>16</sub>"  
(367 x 275 x 100 mm)



**20199**  
**ROVAL™ SEMI-RECESSED HIGH-SPEED HAND DRYER**

**<15 sec.**  
DRYING TIME

**69 dBA**  
NOISE LEVEL

**Voltage:** 120 V (-1) and 240 V (-2)

**Unit Size:**

11" x 15<sup>1</sup>/<sub>2</sub>" x 5<sup>23</sup>/<sub>32</sub>"  
(279 x 394 x 145 mm)

**Wall Opening:**

10<sup>1</sup>/<sub>2</sub>" x 14<sup>5</sup>/<sub>8</sub>" x 3<sup>1</sup>/<sub>4</sub>"  
(267 x 371 x 83 mm)



**0135-1**  
**TURBO-TUFF™ RECESS MOUNTED HIGH-SPEED ADA HAND DRYER (110-120V)**

**<15 sec.**  
DRYING TIME

**68.9-74.3 dBA**  
NOISE LEVEL

**Auto Shut Off:** 60 seconds

**Model Options:**

- 0135-2** Voltage is 208-240 V

**Unit Size:**

12<sup>19</sup>/<sub>32</sub>" x 15<sup>3</sup>/<sub>4</sub>" x 4<sup>1</sup>/<sub>32</sub>"  
(320 x 400 x 102 mm)

**Wall Opening:**

12<sup>5</sup>/<sub>16</sub>" x 15<sup>3</sup>/<sub>16</sub>" x 3<sup>7</sup>/<sub>8</sub>"  
(313 x 386 x 98 mm)



**0198-MH**  
**SAFE-DRI™ MENTAL HEALTH APPROVED RECESSED HIGH-SPEED HAND DRYER**

**<15 sec.**  
DRYING TIME

**66 dBA**  
NOISE LEVEL

**ANTI-LIGATURE**

**Voltage:** 115-120 V (-1) and 208-240 V (-2)

**Unit Size:**

12<sup>5</sup>/<sub>8</sub>" x 15<sup>3</sup>/<sub>4</sub>" x 5<sup>1</sup>/<sub>16</sub>"  
(320 x 400 x 140 mm)

**Wall Opening:**

11<sup>7</sup>/<sub>8</sub>" x 14<sup>3</sup>/<sub>4</sub>" x 5<sup>1</sup>/<sub>8</sub>"  
(303 x 376 x 130 mm)





# MIRRORS

A variety of reflective surfaces and wall mountings, as well as styles ranging from LED mirrors via frameless mirrors to mirrors with shelves and tilting features. Mirror silver guaranteed for 15 years.



## OPTIONAL REFLECTIVE SURFACES

### SUFFIX DESCRIPTION:

- B Tempered Glass** 1/4" (6 mm) polished tempered glass
- C Stainless Steel Mirrors** Type 304 Stainless Steel polished to a #8 mirror finish
- D Lexan Dura-Mir™** Fabricated of 1/4" (6 mm) polycarbonate sheet
- E Plexiglas®** 1/4" (6 mm) acrylic plastic, lightweight and shatter-resistant
- L Laminated Glass** 1/4" (6 mm) thick

Note for Designers: All of the above glazing options are particularly suited to applications where frequent breakage and/or security problems exist. These surfaces are best specified for use in prisons, schools, police stations, psychiatric wards, etc., where shards of broken glass might possibly be used as weapons. The reflective quality of these types of mirrors is not as true as plate glass.

STANDARD MIRROR SIZES													
Width x Height	0535	0537	0600	0600-T	0605	0620	0625	0640	0641	8026	20650	20650-B	20655
16" x 20" (41 x 51 cm)			■		■	■				■			
16" x 24" (41 x 61 cm)			■	■	■	■	■			■			
16" x 30" (41 x 76 cm)	■	■	■	■		■							
18" x 24" (46 x 61 cm)	■		■	■	■	■	■			■			
18" x 30" (46 x 76 cm)	■	■	■	■	■	■	■			■	■	■	■
18" x 36" (46 x 91 cm)	■	■	■	■	■	■	■				■	■	■
20" x 60" (51 x 152 cm)			■			■							
24" x 24" (61 x 61 cm)						■							
24" x 30" (61 x 76 cm)	■		■		■	■	■			■			
24" x 36" (61 x 91 cm)	■		■	■	■	■	■	■	■	■	■	■	■
24" x 42" (61 x 107 cm)			■			■							
24" x 48" (61 x 122 cm)			■			■							
24" x 60" (61 x 152 cm)			■			■							
24" x 72" (61 x 183 cm)			■										
30" x 36" (76 x 91 cm)			■			■		■	■				
30" x 48" (76 x 122 cm)						■							
36" x 36" (91 x 91 cm)			■			■							
36" x 48" (91 x 122 cm)						■							
48" x 30" (122 x 76 cm)			■		■	■							
48" x 36" (122 x 91 cm)			■		■	■		■	■				
60" x 24" (152 x 61 cm)			■		■	■							
60" x 36" (152 x 91 cm)			■		■	■		■	■				
72" x 36" (183 x 91 cm)			■		■	■							

Custom sizes available upon request. Standard glazing is glass. See optional reflective surfaces above.

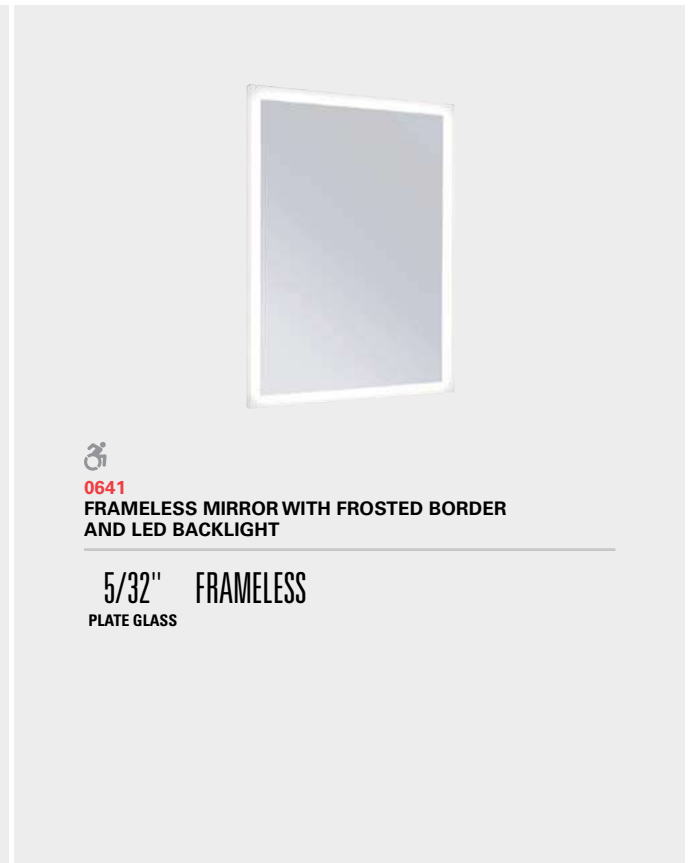



**0600**  
ANGLE FRAME MIRROR

**15 YEAR**  
WARRANTY

**Model Option:**  
0600-41 Matte Black.



**0620**  
CHANNEL FRAME MIRROR

**15 YEAR**  
WARRANTY



**20650**  
ROVAL™ MIRROR  
**20655**  
ROVAL™ MIRROR  
WITH INTEGRAL SHELF

**15 YEAR**  
WARRANTY

**Model Options:**  
20650-B Mirror with tempered glass.



**0605**  
ANGLE FRAME MIRROR  
WITH SHELF  
**0625**  
CHANNEL FRAME MIRROR  
WITH SHELF

**15 YEAR**  
WARRANTY



**0535**  
FIXED TILT MIRROR

**15 YEAR**  
WARRANTY



**0600-T**  
ADJUSTABLE TILT MIRROR

**TILT** **15 YEAR**  
**FRAME** **WARRANTY**



8026

FRAMELESS STAINLESS STEEL MIRROR

15 YEAR  
WARRANTY



8287

FRAMELESS MIRROR

FRAMELESS 15 YEAR  
WARRANTY

### VELARE™ COLLECTION

**ALL-IN-ONE Cabinet houses a**  
– paper towel dispenser or high-speed hand dryer and  
– a liquid soap- or foam-soap dispenser  
**Collection includes mirror fillers for design flexibility.**

Backlit icons etched into the mirror facilitate an intuitive user experience.

ARTFULLY CONCEALED FRAMELESS





**0952**

**RECESSED STAINLESS STEEL MEDICINE CABINET**

**ADJUSTABLE**

SHELVES

**Overall Dimensions:**

18¼" x 24¼" x 4½"  
(464 x 616 x 114 mm)

**Wall Opening:**

16" x 22¾" x 3½"  
(406 x 578 x 89 mm)

**Model Option:**

**0952-B** Larger than 0952.

**Overall Dimensions:**

24" x 26" x 4⅞"  
(610 x 660 x 124 mm)

**Wall Opening:**

21¾" x 24½" x 3½"  
(550 x 620 x 89 mm)



**0953**

**SURFACE MOUNTED STAINLESS STEEL MEDICINE CABINET**

**ADJUSTABLE**

SHELVES

**Overall Dimensions:**

18¼" x 24¼" x 4¾"  
(464 x 616 x 121 mm)



**8340**

**RECESSED MEDICINE CABINET, POWDER COATED STEEL, MIRROR FRAME STAINLESS STEEL**

**1/4"**

PLATE GLASS

**ADJUSTABLE**

SHELVES

**Overall Dimensions:**

18¼" x 24¼" x 4⅞"  
(465 x 615 x 120 mm)

**Wall Opening:**

16" x 22¾" x 3½"  
(406 x 578 x 89 mm)

**Model Options:**

**8338** Smaller and has two adjustable white baked enamel steel shelves.

**Overall Dimensions:**

14⅞" x 20⅞" x 5"  
(359 x 513 x 125 mm)

**8339** Larger than 8338.

16¾" x 22¾" x 5"  
(411 x 564 x 127 mm)



## DETAILS

UP TO  
**50**  
LB. CAPACITY

### LARGE WEIGHT CAPACITY

Baby changing stations have been tested using ASTM F2285-04 and EN 12221-1 protocol for a static load and in addition have been tested to hold a weight up to 250 lbs [113kg]. Some Baby Changing Stations have been tested for holding a weight >250lbs.



### ADA ACCESSIBILITY STANDARD COMPLIANT

Units are engineered to comply with the standards set forth by the Americans with Disabilities Act for accessibility and safety.



### EASY OPEN AND CLOSE

Units are designed for easy one-handed operation and shaped to safely cradle a child's body.

# BABY CHANGING STATIONS

PLASTIC



PLASTIC/  
STAINLESS STEEL



STAINLESS STEEL





**9014**  
**SURFACE MOUNTED HORIZONTAL PLASTIC**  
**BABY CHANGING STATION**

≤250 lbs.

**Overall Dimensions:**

Closed:  
 35<sup>5</sup>/<sub>32</sub>" x 24<sup>1</sup>/<sub>4</sub>" x 3<sup>7</sup>/<sub>16</sub>"  
 (893 x 616 x 98 mm)

Open:  
 35<sup>5</sup>/<sub>32</sub>" x 24<sup>1</sup>/<sub>4</sub>" x 22<sup>1</sup>/<sub>32</sub>"  
 (893 x 616 x 560 mm)



**9014-41**  
**SURFACE MOUNTED HORIZONTAL MATTE BLACK**  
**BABY CHANGING STATION**

≤250 lbs.

**Overall Dimensions:**

Closed:  
 35<sup>5</sup>/<sub>32</sub>" x 24<sup>1</sup>/<sub>4</sub>" x 3<sup>7</sup>/<sub>16</sub>"  
 (893 x 616 x 98 mm)

Open:  
 35<sup>5</sup>/<sub>32</sub>" x 24<sup>1</sup>/<sub>4</sub>" x 22<sup>1</sup>/<sub>32</sub>"  
 (893 x 616 x 560 mm)



**9012**  
**SURFACE MOUNTED PLASTIC BABY CHANGING STATION**

≤250 lbs.

**Overall Dimensions:**

Closed:  
 36" x 22" x 4"  
 (914 x 559 x 102 mm)

Open:  
 36" x 22" x 20<sup>7</sup>/<sub>16</sub>"  
 (914 x 559 x 519 mm)



**9015**  
**SURFACE MOUNTED VERTICAL PLASTIC**  
**BABY CHANGING STATION**

≤250 lbs.

**Overall Dimensions:**

Closed:  
 24<sup>1</sup>/<sub>4</sub>" x 35<sup>5</sup>/<sub>32</sub>" x 3<sup>7</sup>/<sub>16</sub>"  
 (616 x 893 x 98 mm)

Open:  
 24<sup>1</sup>/<sub>4</sub>" x 35<sup>5</sup>/<sub>32</sub>" x 32<sup>15</sup>/<sub>16</sub>"  
 (616 x 893 x 837 mm)

## BABY CHANGING STATIONS



**9022**  
SURFACE MOUNTED HORIZONTAL PLASTIC/  
STAINLESS STEEL BABY CHANGING STATION

≤250 lbs.

**Overall Dimensions:**

Closed:

35<sup>5</sup>/<sub>32</sub>" x 24<sup>1</sup>/<sub>4</sub>" x 3<sup>7</sup>/<sub>8</sub>"  
(893 x 616 x 98 mm)

Open:

35<sup>5</sup>/<sub>32</sub>" x 24<sup>1</sup>/<sub>4</sub>" x 22<sup>1</sup>/<sub>32</sub>"  
(893 x 616 x 560 mm)



**9024-41**  
SURFACE MOUNTED HORIZONTAL MATTE BLACK  
STAINLESS STEEL PANEL BABY CHANGING STATION

≤250 lbs.

**Overall Dimensions:**

Closed:

35<sup>5</sup>/<sub>32</sub>" x 24<sup>1</sup>/<sub>4</sub>" x 3<sup>7</sup>/<sub>8</sub>"  
(893 x 616 x 98 mm)

Open:

35<sup>5</sup>/<sub>32</sub>" x 24<sup>1</sup>/<sub>4</sub>" x 22<sup>1</sup>/<sub>32</sub>"  
(893 x 616 x 560 mm)



**9026-41**  
SURFACE MOUNTED HORIZONTAL  
STAINLESS STEEL (MATTE BLACK/MATTE BLACK)  
BABY CHANGING STATION

≤250 lbs.

**Overall Dimensions:**

Closed:

35<sup>5</sup>/<sub>32</sub>" x 24<sup>1</sup>/<sub>4</sub>" x 3<sup>7</sup>/<sub>8</sub>"  
(893 x 616 x 98 mm)

Open:

35<sup>5</sup>/<sub>32</sub>" x 24<sup>1</sup>/<sub>4</sub>" x 22<sup>1</sup>/<sub>32</sub>"  
(893 x 616 x 560 mm)



**9020**  
SURFACE MOUNTED TODDLER SAFETY SEAT

≤250 lbs.

**Overall Dimensions:**

Closed:

12<sup>1</sup>/<sub>2</sub>" x 21<sup>3</sup>/<sub>4</sub>" x 5<sup>1</sup>/<sub>2</sub>"  
(318 x 552 x 140 mm)

Open:

12<sup>1</sup>/<sub>2</sub>" x 21<sup>3</sup>/<sub>4</sub>" x 11<sup>1</sup>/<sub>8</sub>"  
(318 x 552 x 283 mm)



**9018-41**  
**RECESSED HORIZONTAL MATTE BLACK**  
**STAINLESS STEEL BABY CHANGING STATION**

≤250 lbs.

**Overall Dimensions:**

Closed:  
 35<sup>5</sup>/<sub>32</sub>" x 24<sup>1</sup>/<sub>4</sub>" x 3<sup>7</sup>/<sub>16</sub>"  
 (893 x 616 x 98 mm)

Open:  
 35<sup>5</sup>/<sub>32</sub>" x 24<sup>1</sup>/<sub>4</sub>" x 22<sup>1</sup>/<sub>32</sub>"  
 (893 x 616 x 560 mm)



**9018-9-41**  
**SURFACE MOUNTED HORIZONTAL MATTE BLACK**  
**STAINLESS STEEL BABY CHANGING STATION**

≤250 lbs.

**Overall Dimensions:**

Closed:  
 39<sup>5</sup>/<sub>32</sub>" x 28<sup>1</sup>/<sub>4</sub>" x 3<sup>5</sup>/<sub>16</sub>"  
 (995 x 718 x 10 mm)

Open:  
 39<sup>5</sup>/<sub>32</sub>" x 28<sup>1</sup>/<sub>4</sub>" x 18<sup>1</sup>/<sub>16</sub>"  
 (995 x 718 x 460 mm)



**9017**  
**RECESSED VERTICAL STAINLESS STEEL**  
**BABY CHANGING STATION**

≤250 lbs.

**Overall Dimensions:**

Closed:  
 28<sup>1</sup>/<sub>4</sub>" x 39<sup>5</sup>/<sub>32</sub>" x 3<sup>5</sup>/<sub>16</sub>"  
 (718 x 994 x 10 mm)

Open:  
 28<sup>1</sup>/<sub>4</sub>" x 39<sup>5</sup>/<sub>32</sub>" x 29<sup>3</sup>/<sub>16</sub>"  
 (718 x 994 x 746 mm)

**Wall Opening:**  
 24<sup>1</sup>/<sub>2</sub>" x 35<sup>1</sup>/<sub>2</sub>" x 4" min  
 (622 x 902 x 102 mm)



**9017-9**  
**SURFACE MOUNTED VERTICAL STAINLESS STEEL**  
**BABY CHANGING STATION**

≤250 lbs.

**Overall Dimensions:**

Closed:  
 28<sup>1</sup>/<sub>4</sub>" x 39<sup>5</sup>/<sub>32</sub>" x 3<sup>5</sup>/<sub>16</sub>"  
 (718 x 995 x 100 mm)

Open:  
 28<sup>1</sup>/<sub>4</sub>" x 39<sup>5</sup>/<sub>32</sub>" x 32<sup>3</sup>/<sub>8</sub>"  
 (718 x 995 x 822 mm)

**Wall Opening:**  
 24<sup>1</sup>/<sub>2</sub>" x 35<sup>1</sup>/<sub>2</sub>" x 4" min  
 (622 x 902 x 102 mm)

## BABY CHANGING STATIONS



**9018-9**  
**SURFACE MOUNTED HORIZONTAL STAINLESS STEEL**  
**BABY CHANGING STATION**

≤250 lbs.

**Overall Dimensions:**

Closed:	Open:
39 <sup>7</sup> / <sub>32</sub> " x 28 <sup>1</sup> / <sub>4</sub> " x 3 <sup>3</sup> / <sub>16</sub> "	39 <sup>7</sup> / <sub>32</sub> " x 28 <sup>1</sup> / <sub>4</sub> " x 18 <sup>1</sup> / <sub>8</sub> "
(995 x 718 x 84 mm)	(995 x 718 x 460 mm)



**9018**  
**RECESSED HORIZONTAL STAINLESS STEEL**  
**BABY CHANGING STATION**

≤250 lbs.

**Overall Dimensions:**

Closed:	Open:
39 <sup>7</sup> / <sub>32</sub> " x 28 <sup>1</sup> / <sub>4</sub> " x 3 <sup>3</sup> / <sub>16</sub> "	39 <sup>7</sup> / <sub>32</sub> " x 28 <sup>1</sup> / <sub>4</sub> " x 18 <sup>1</sup> / <sub>8</sub> "
(995 x 718 x 10 mm)	(995 x 718 x 460 mm)

**Wall Opening:**  
 35<sup>1</sup>/<sub>2</sub>" x 24<sup>1</sup>/<sub>2</sub>" x 4" min  
 (902 x 622 x 102 mm)



**9013**  
**RECESSED HEAVY-DUTY STAINLESS STEEL**  
**BABY CHANGING STATION**

>250 lbs.

**Overall Dimensions:**

Closed:	Open:
37" x 25 <sup>1</sup> / <sub>2</sub> " x 3 <sup>3</sup> / <sub>8</sub> "	37" x 25 <sup>1</sup> / <sub>2</sub> " x 17 <sup>3</sup> / <sub>4</sub> "
(940 x 648 x 10 mm)	(940 x 648 x 451 mm)



**9013-9**  
**SURFACED MOUNTED HEAVY-DUTY STAINLESS STEEL**  
**BABY CHANGING STATION**

>250 lbs.

**Overall Dimensions:**

Closed:	Open:
37" x 25 <sup>1</sup> / <sub>2</sub> " x 4 <sup>3</sup> / <sub>8</sub> "	37" x 25 <sup>1</sup> / <sub>2</sub> " x 21 <sup>3</sup> / <sub>4</sub> "
(940 x 648 x 111 mm)	(940 x 648 x 552 mm)



# SHELVES

Various configurations, sizes, and styles, including platform, recessed, and folding utility shelving.

**SHELVES**  
**ALL STAINLESS STEEL IS TYPE 304 WITH SATIN FINISH,**  
**UNLESS OTHERWISE NOTED.**



**RECESSED  
SHELF**



**SURFACED  
MOUNTED  
SHELF**



**0690**  
**SHELF WITH RAISED EDGES**

**SURFACE**      **RAISED**  
**MOUNTED**      **EDGES**

See chart for standard sizes.

	Model Numbers					
	0690	0692		0694	20692	
Standard Sizes:	6" depth (152 mm)	5" depth (127 mm)	6" depth (152 mm)	8" depth (203 mm)	5" depth (127 mm)	6" depth (152 mm)
Length						
12" (305 mm)		■	■	■		■
16" (406 mm)		■	■	■		
18" (457 mm)	■	■	■	■	■	■
24" (610 mm)	■	■	■	■	■	■
30" (762 mm)		■	■	■		■
36" (914 mm)		■	■	■		■
48" (1219 mm)		■	■	■	■	■
60" (1524 mm)		■	■	■	■	■
72" (1829 mm)						■



**0692 SERIES**  
SURFACE MOUNTED SHELF

**Model Options:**  
**0692-5xx** 5" Depth.  
**0692-6xx** 6" Depth.  
**0692-8xx** 8" Depth.

See chart for standard sizes.



**0698**  
FOLDING UTILITY SHELF FOR TOILET COMPARTMENTS

**SURFACE**      **FOLD DOWN**  
MOUNTED              TYPE

**Overall Dimensions:**  
14<sup>5</sup>/<sub>8</sub>" x 5<sup>1</sup>/<sub>8</sub>"  
(371 x 148 mm)



**0412**  
RECESSED SHELF

**Overall Dimensions:**  
18" x 8" x 4<sup>1</sup>/<sub>4</sub>" min  
(457 x 203 x 108 mm)

**Wall Opening:**  
16<sup>1</sup>/<sub>2</sub>" x 6<sup>1</sup>/<sub>2</sub>" x 4" min  
(419 x 165 x 102 mm)



**0694 SERIES**  
SURFACE MOUNTED SHELF  
WITH BACKSPLASH



**20692 SERIES**  
ROVAL™ SURFACE MOUNTED  
SHELF, 6" DEPTH

For various lengths add suffix-6XX.

See chart for standard sizes.



# FEMININE HYGIENE VENDORS

Recessed, semi-recessed, or surface-mounted dispensers in various capacities. Coin boxes for 25ct and 50ct are separately keyed from door locks.

## FEMININE HYGIENE VENDORS AND DISPOSALS



**SANITARY  
NAPKIN/TAMPON  
VENDOR**



**0464**

**SEMI-RECESSED STAINLESS STEEL  
SANITARY NAPKIN & TAMPON VENDOR**

**27**

**TAMPON  
CAPACITY**

**Model Option:**  
**0864** Surface mounted.

**Unit Size:**  
13<sup>3</sup>/<sub>4</sub>" x 28<sup>1</sup>/<sub>8</sub>" x 6<sup>1</sup>/<sub>2</sub>"  
(349 x 714 x 165 mm)

**Wall Opening:**  
12<sup>1</sup>/<sub>2</sub>" x 26<sup>1</sup>/<sub>2</sub>" x 1" to 6"  
(318 x 673 x 25 to 152 mm)



**6468**

**SIMPLICITY™ RECESSED STAINLESS STEEL  
SANITARY NAPKIN & TAMPON VENDOR**

**27**

**TAMPON  
CAPACITY**

**Model Option:**  
**64684** Designed for 4" (102 mm) wall opening;  
dispenses 15 napkins and 23 tampons.

**Unit Size:**  
17<sup>1</sup>/<sub>4</sub>" x 27<sup>1</sup>/<sub>4</sub>" x 6<sup>1</sup>/<sub>2</sub>"  
(438 x 692 x 165 mm)

**Wall Opening:**  
16" x 26" x 6<sup>1</sup>/<sub>4</sub>"  
(406 x 660 x 159 mm)



**0468**

**RECESSED STAINLESS STEEL  
SANITARY NAPKIN & TAMPON VENDOR**

**27**

**TAMPON  
CAPACITY**

**Model Options:**

**0468-2** Semi-recessed with a stainless steel collar.

**04684** Designed for 4" (102 mm) wall. Dispenses 15 napkins, 23 tampons.

**Unit Size:**

17¼" x 27¼" x 6½"  
(438 x 692 x 165 mm)

**Wall Opening:**

16" x 26" x 6"  
(406 x 660 x 152 mm)



**204684**

**ROVAL™ RECESSED STAINLESS STEEL  
SANITARY NAPKIN & TAMPON VENDOR**

**22**

**TAMPON  
CAPACITY**

**Model Option:**

**204684-9** Surface mounted with a stainless steel collar.

**Unit Size:**

17⅞" x 27¾" x 5⅝"  
(440 x 705 x 143 mm)

**Wall Opening:**

15⅞" x 26⅞" x 4"  
(397 x 664 x 102 mm)



## DETAILS



### TUMBLER LOCKS

Our tumbler locks provide convenience and security with an elegant look.



### SAFE, EASY DISPENSING

Dispensing and storage options vary, from single-roll to multiple-rolls or jumbo-roll dispensers.



### VIEWING SLOT

Slot in front cover of jumbo-roll dispensers provides easy visual indication of remaining tissue supply.

# TOILET TISSUE DISPENSERS

A broad range of designs for a broad range of applications.



**SHELF AND  
DOUBLE  
TOILET TISSUE  
HOLDER**



**DUAL ROLL  
TOILET TISSUE  
DISPENSERS**



**RECESSED  
ADA-COMPLIANT  
TOILET TISSUE  
AND SEAT COVER  
DISPENSER WITH  
WASTE DISPOSAL**

See our Toilet Tissue  
Combination Units,  
pages 125-127.



**0030**  
**SURFACE MOUNTED DUAL ROLL TOILET TISSUE DISPENSER**

2

TOILET PAPER CAPACITY (ROLLS)

**Unit Size:**  
6" x 12" x 6½"  
(152 x 305 x 165 mm)



**0030-41**  
**MATTE BLACK TOILET TISSUE DISPENSER, TWIN HIDE-A-ROLL – SURFACE MOUNTED**

2

TOILET PAPER CAPACITY (ROLLS)

**Unit Size:**  
6" x 12" x 6½"  
(152 x 305 x 165 mm)



**20030**  
**ROVAL™ SURFACE MOUNTED TWIN HIDE-A-ROLL TOILET TISSUE DISPENSER**

2

TOILET PAPER CAPACITY (ROLLS)

**Model Option:**  
**20031** With flange for semi-recessed mounting.

**Overall Dimensions:**  
6⅞" x 12⅞" x 6½"  
(154 x 308 x 165 mm)



**0031**  
**RECESSED DUAL ROLL TOILET TISSUE DISPENSER**

2

TOILET PAPER CAPACITY (ROLLS)

**Unit Size:** 8" x 14" x 6½"  
(203 x 356 x 165 mm)  
**Wall Opening:** 6¼" x 12¼" x 3⅞"  
(159 x 311 x 86 mm)



**0032**  
**PARTITION MOUNTED DUAL ACCESS DUAL ROLL TOILET TISSUE DISPENSER**

4

TOILET PAPER CAPACITY (ROLLS)

**PARTITION MOUNTED**

**Unit Size:** 14" x 14⅞" x 10"  
(356 x 359 x 255 mm)  
**Partition Opening:** 12⅞" x 12¼" x ½-2½"  
(308 x 311 x 13-64 mm)

## TOILET TISSUE DISPENSERS



0039

**SURFACE MOUNTED LOW PROFILE TWIN 9" JUMBO ROLL TOILET TISSUE DISPENSER**

**TWIN JUMBO**

TOILET PAPER  
CAPACITY (ROLLS)

**Overall Dimensions:**  
20 $\frac{1}{2}$ " x 11 $\frac{3}{16}$ " x 4 $\frac{1}{16}$ "  
(521 x 284 x 119 mm)



0040

**SURFACE MOUNTED TWIN 9" JUMBO ROLL TOILET TISSUE DISPENSER**

**TWIN JUMBO**

TOILET PAPER  
CAPACITY (ROLLS)

**Overall Dimensions:**  
20 $\frac{13}{16}$ " x 11 $\frac{3}{8}$ " x 6 $\frac{3}{16}$ "  
(529 x 289 x 157 mm)



0042

**SURFACE MOUNTED 9" JUMBO ROLL TOILET TISSUE DISPENSER**

**JUMBO**

TOILET PAPER  
CAPACITY (ROLLS)

**Model Option:**  
0046 Jumbo 12" roll, surface mounted.

**Overall Dimensions:**  
10 $\frac{5}{8}$ " x 10 $\frac{5}{8}$ " x 4 $\frac{1}{2}$ "  
(270 x 270 x 114 mm)



0042-41

**MATTE BLACK SURFACE MOUNTED 9" JUMBO ROLL TOILET TISSUE DISPENSER**

**JUMBO**

TOILET PAPER  
CAPACITY (ROLLS)

**Overall Dimensions:**  
10 $\frac{5}{8}$ " x 10 $\frac{5}{8}$ " x 4 $\frac{1}{2}$ "  
(270 x 270 x 114 mm)



**7402-BSM**  
**TOILET TISSUE HOLDER (SINGLE) – SURFACE MOUNTED, BRIGHT**

1

**TOILET PAPER CAPACITY (ROLLS)**

**Model Option:**  
**7402-B** Recessed, bright.

**Overall Dimensions:**  
6<sup>5</sup>/<sub>16</sub>" x 6<sup>5</sup>/<sub>16</sub>"  
(160 x 160 mm)



**7402-HB**  
**TOILET TISSUE HOLDER WITH HOOD (SINGLE) – RECESSED, BRIGHT**

1

**TOILET PAPER CAPACITY (ROLLS)**

**Model Option:**  
**7402-HS** Recessed, satin.

**Overall Dimensions:**  
6<sup>5</sup>/<sub>16</sub>" x 6<sup>5</sup>/<sub>16</sub>"  
(160 x 160 mm)



**7402-SSM**  
**TOILET TISSUE HOLDER (SINGLE) – SURFACE MOUNTED, SATIN**

1

**TOILET PAPER CAPACITY (ROLLS)**

**Model Option:**  
**7402-S** Recessed, satin.

**Overall Dimensions:**  
6<sup>5</sup>/<sub>16</sub>" x 6<sup>5</sup>/<sub>16</sub>"  
(160 x 160 mm)



**7402-HBSM**  
**TOILET TISSUE HOLDER WITH HOOD (SINGLE) – SURFACE MOUNTED, BRIGHT**

1

**TOILET PAPER CAPACITY (ROLLS)**

**Model Option:**  
**7402-HSSM** Surface mounted, satin.

**Overall Dimensions:**  
10<sup>5</sup>/<sub>16</sub>" x 10<sup>5</sup>/<sub>16</sub>" x 4<sup>1</sup>/<sub>2</sub>"  
(270 x 270 x 114 mm)

## TOILET TISSUE DISPENSERS

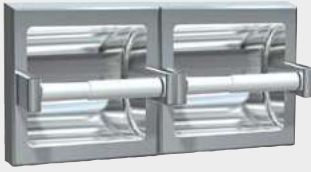

**74022-BSM**  
TOILET TISSUE HOLDER (DOUBLE)  
– SURFACE MOUNTED, BRIGHT

2

TOILET PAPER  
CAPACITY (ROLLS)

**Model Option:**  
74022-B Recessed, bright.

**Overall Dimensions:**  
12<sup>5</sup>/<sub>8</sub>" x 6<sup>5</sup>/<sub>16</sub>" x 2"  
(320 x 160 x 51 mm)



**74022-HBSM**  
TOILET TISSUE HOLDER WITH  
HOOD (DOUBLE) – SURFACE  
MOUNTED, BRIGHT

2

TOILET PAPER  
CAPACITY (ROLLS)

**Model Option:**  
74022-HS Recessed, satin.

**Overall Dimensions:**  
12<sup>5</sup>/<sub>8</sub>" x 6<sup>5</sup>/<sub>16</sub>" x 2"  
(320 x 160 x 51 mm)



**74022-HSSM**  
TOILET TISSUE HOLDER WITH  
HOOD (DOUBLE) – SURFACE  
MOUNTED, SATIN

2

TOILET PAPER  
CAPACITY (ROLLS)

**Model Option:**  
74022-HS Recessed, satin.

**Overall Dimensions:**  
12<sup>5</sup>/<sub>8</sub>" x 6<sup>5</sup>/<sub>16</sub>" x 2"  
(320 x 160 x 51 mm)



**74022-SSM**  
TOILET TISSUE HOLDER (DOUBLE)  
– SURFACE MOUNTED, SATIN

2

TOILET PAPER  
CAPACITY (ROLLS)

**Model Option:**  
74022-S Recessed, satin.

**Overall Dimensions:**  
12<sup>5</sup>/<sub>8</sub>" x 6<sup>5</sup>/<sub>16</sub>" x 2"  
(320 x 160 x 51 mm)



**7403-B**  
SPARE ROLL TOILET TISSUE  
HOLDER – RECESSED,  
SATIN FINISH

2

TOILET PAPER  
CAPACITY (ROLLS)

**Model Option:**  
7403-S Satin.

**Overall Dimensions:**  
6<sup>5</sup>/<sub>16</sub>" x 6<sup>1</sup>/<sub>4</sub>" x 6<sup>13</sup>/<sub>16</sub>"  
(160 x 160 x 173 mm)



**7305-S**  
SURFACE MOUNTED TOILET  
TISSUE HOLDER, SATIN FINISH

1

TOILET PAPER  
CAPACITY (ROLLS)

**Model Options:**  
7305-41 Surface mounted,  
matte black.  
7305-B Surface mounted, bright.

**Overall Dimensions:**  
6<sup>1</sup>/<sub>16</sub>" x 12<sup>1</sup>/<sub>8</sub>" x 6<sup>1</sup>/<sub>2</sub>"  
(154 x 308 x 165 mm)



**0705-Z**  
**SURFACE MOUNTED ZAMAK  
CHROME PLATED TOILET  
TISSUE HOLDER**

1

**TOILET PAPER  
CAPACITY (ROLLS)**

**Overall Dimensions:**  
5<sup>7</sup>/<sub>8</sub>" x 1<sup>7</sup>/<sub>16</sub>" x 2<sup>3</sup>/<sub>4</sub>"  
(149 x 37 x 70 mm)



**0697-GAL**  
**SURFACE MOUNTED STAINLESS  
STEEL SHELF AND DOUBLE TOILET  
TISSUE HOLDER**

2

**TOILET PAPER  
CAPACITY (ROLLS)**

**Overall Dimensions:**  
18" x 4<sup>13</sup>/<sub>16</sub>" x 5"  
(457 x 106 x 127 mm)



**7305-2B**  
**SURFACE MOUNTED DOUBLE  
TOILET TISSUE HOLDER**

2

**TOILET PAPER  
CAPACITY (ROLLS)**

**Model Options:**  
**7305-2-41** Matte black.  
**7305-2S** Satin.

**Overall Dimensions:**  
3<sup>1</sup>/<sub>2</sub>" x 2" x 3<sup>3</sup>/<sub>8</sub>"  
(343 x 51 x 98 mm)



**7314**  
**SINGLE TOILET PAPER ROLL  
HOLDER**

1

**TOILET PAPER  
CAPACITY (ROLLS)**

**Overall Dimensions:**  
5<sup>3</sup>/<sub>16</sub>" x 3<sup>3</sup>/<sub>8</sub>" x 2<sup>3</sup>/<sub>16</sub>"  
(131 x 86 x 56 mm)



**7314-H**  
**TOILET TISSUE ROLL HOLDER  
(SINGLE), HOODED**

1

**TOILET PAPER  
CAPACITY (ROLLS)**

**Overall Dimensions:**  
5<sup>4</sup>/<sub>16</sub>" x 4<sup>3</sup>/<sub>4</sub>" x 3<sup>5</sup>/<sub>8</sub>"  
(144 x 121 x 98 mm)



**7316**  
**TOILET TISSUE SPARE  
HOLDER, VERTICAL**

1

**TOILET PAPER  
CAPACITY (ROLLS)**

**Overall Dimensions:**  
3<sup>1</sup>/<sub>2</sub>" x 6<sup>7</sup>/<sub>16</sub>" x 4"  
(90 x 163.5 x 102 mm)

## TOILET TISSUE DISPENSERS



**0264-1**  
**SURFACE MOUNTED DOUBLE  
 CAST ALUMINUM TOILET  
 TISSUE HOLDER – SPINDLES**  
 ABS-THERMOPLASTIC

**2**

**TOILET PAPER  
 CAPACITY (ROLLS)**

**Model Options:**

**0264-12** Unrestricted delivery,  
 theft-resistant spindle.  
**0264-1A** Unrestricted delivery.  
**0264-1A2** Unrestricted delivery,  
 theft-resistant spindle.

**Overall Dimensions:**

13" x 1¾" x 4¾"  
 (330 x 45 x 120 mm)



**0263-1**  
**SURFACE MOUNTED SINGLE  
 CAST ALUMINUM ROLL TOILET  
 TISSUE DISPENSER – SPINDLES**  
 ABS-THERMOPLASTIC

**1**

**TOILET PAPER  
 CAPACITY (ROLLS)**

**CONTROLLED**

**DELIVERY**

**Model Option:**

**0263-1A** Unrestricted delivery.

**Overall Dimensions:**

6½" x 1¾" x 4"  
 (165 x 45 x 102 mm)



**8010**  
**SURFACE MOUNTED TOILET TISSUE  
 HOLDER (SINGLE) HIGH POLISHED  
 CHROME PLATED STEEL**

**1**

**TOILET PAPER  
 CAPACITY (ROLLS)**

**Overall Dimensions:**

5⅝" x 2¾" x 4¼"  
 (143 x 60 x 108 mm)



**048234**  
**RECESSED MULTI-ROLL  
 TOILET TISSUE DISPENSER**

**4**

**TOILET PAPER  
 CAPACITY (ROLLS)**

**Unit Size:**

17⅞" x 20" x 4¼"  
 (441 x 508 x 108 mm)

**Wall Opening:**

15¾" x 18⅞" x 4"  
 (400 x 467 x 102 mm)



**0710**  
**SURFACE MOUNTED TOILET TISSUE  
 HOLDER (SINGLE) HIGH POLISHED  
 CHROME PLATED STEEL**

**1**

**TOILET PAPER  
 CAPACITY (ROLLS)**

**Overall Dimensions:**

6" x 2¾" x 4¼"  
 (152 x 70 x 108 mm)



**0715**  
**SURFACE MOUNTED DOUBLE  
 TOILET TISSUE HOLDER HIGH  
 POLISHED CHROME PLATED STEEL**

**2**

**TOILET PAPER  
 CAPACITY (ROLLS)**

**Overall Dimensions:**

12⅞" x 2¾" x 4¼"  
 (314 x 70 x 108 mm)



**0266**  
**STAINLESS STEEL VANDAL-RESISTANT HOOD**

**1** **SURFACE**  
TOILET PAPER  
CAPACITY (ROLLS) MOUNTED

**Model Options:**  
**0267** Vandal-resistant hood for model 0264-1 (hood only)  
– surface mounted.

**Unit Size:**  
7¼" x 7¾" x 6½"  
(184 x 197 x 175 mm)



**R-002**  
**THEFT-RESISTANT SPINDLE  
FOR 0263 AND 0264 SERIES**

**1**  
TOILET PAPER  
CAPACITY (ROLLS)

**Overall Dimensions:**  
4"  
(102 mm)



**7303-B**  
**EXTRA ROLL TOILET TISSUE HOLDER**

**1** **SURFACE**  
TOILET PAPER  
CAPACITY (ROLLS) MOUNTED

**Model Option:**  
**7303-S** Satin Finish.

**Overall Dimensions:**  
1" x 5" x 4¾"  
(25 x 127 x 111 mm)



**8020**  
**SURFACE MOUNTED SAV-HAFTOILET TISSUE HOLDER  
1/8" (3MM) THICK CLEAR ANODIZED ALUMINUM  
WITH A SATIN FINISH**

**1**  
TOILET PAPER  
CAPACITY (ROLLS)

**Overall Dimensions:**  
5/8" x 2" x 3½"  
(130 x 51 x 79 mm)

## TOILET TISSUE DISPENSERS



**R-005**  
SPINDLE FOR CORELESS ROLLS

1  
TOILET PAPER  
CAPACITY (ROLLS)

**Overall Dimensions:**  
5 $\frac{3}{8}$ "  
(137 mm)



**R-009**  
THEFT-RESISTANT SPINDLE

1  
TOILET PAPER  
CAPACITY (ROLLS)

**Overall Dimensions:**  
4" x 1 $\frac{3}{16}$ "  
(102 x 30 mm)



**R-003**  
CHROME-PLATED SPINDLE

1  
TOILET PAPER  
CAPACITY (ROLLS)

**Overall Dimensions:**  
4"  
(102 mm)



**R-004**  
ROLLER FOR 0030 TOILET TISSUE DISPENSER SERIES

1  
TOILET PAPER  
CAPACITY (ROLLS)

**Overall Dimensions:**  
4"  
(102 mm)



# TOILET SEAT COVER DISPENSERS

Have a seat – matching designs for maximum comfort during downtime.



**RECESSED  
TOILET SEAT  
COVER  
DISPENSERS**



**SURFACE  
MOUNTED  
TOILET SEAT  
COVER  
DISPENSERS**



**0477**

**RECESSED TOILET SEAT  
COVER DISPENSER**

**500** SINGLE  
OR HALF-FOLD  
PAPER SEAT  
COVERS

**Overall Dimensions:**  
17¼" x 12¾" x 2⅝"  
(438 x 324 x 66 mm)

**Wall Opening:**  
15¾" x 11¼" x 2⅝"  
(400 x 285 x 60 mm)



**0477-SM**

**SURFACE MOUNTED TOILET SEAT  
COVER DISPENSER**

**250** SINGLE  
OR HALF-FOLD  
PAPER SEAT  
COVERS

**Unit Size:**  
17¼" x 12¾" x 2⅝"  
(438 x 324 x 60 mm)



**0477-SM-41**

**MATTE BLACK SURFACE  
MOUNTED TOILET SEAT  
COVER DISPENSER**

**250** SINGLE  
OR HALF-FOLD  
PAPER SEAT  
COVERS

**Unit Size:**  
15¾" x 11" x 1⅞"  
(400 x 279 x 48 mm)

## TOILET SEAT COVER DISPENSERS



**20477-SM**  
**ROVAL™ SURFACE MOUNTED  
SEAT COVER DISPENSER**

**250** SINGLE  
OR HALF-FOLD  
PAPER SEAT  
COVERS

**Overall Dimensions:**  
15¾" x 11" x 2⅝"  
(400 x 280 x 60 mm)



**6477**  
**SIMPLICITY™ RECESSED TOILET  
SEAT COVER DISPENSER**

**500** SINGLE  
OR HALF-FOLD  
PAPER SEAT  
COVERS

**Unit Size:**  
17¼" x 12¾" x 2⅞"  
(438 x 324 x 73 mm)  
**Wall Opening:**  
15¾" x 11½" x 2⅝"  
(400 x 292 x 60 mm)



**6477-9**  
**SIMPLICITY™ SURFACE MOUNTED  
TOILET SEAT COVER DISPENSER**

**500** SINGLE  
OR HALF-FOLD  
PAPER SEAT  
COVERS

**Overall Dimensions:**  
17¼" x 12¾" x 2⅞"  
(438 x 324 x 73 mm)



# HYGIENE DISPOSALS

Sensitive attention for the most hygienic waste management. Sensitive designs integrated into the aesthetic lines and functional applications – from capacity management in high traffic areas to withdrawn humbleness in premium restrooms.



**SANITARY  
WASTE  
RECEPTACLE**



**SANITARY  
WASTE  
RECEPTACLE**



0472

**PARTITION MOUNTED DUAL ACCESS  
NAPKIN DISPOSAL**

**1.5 gal.**  
WASTE CAPACITY  
(5.7 L)

**PARTITION  
MOUNTED**

**Model Option:**

**0472-1** Waste receptacle unit with lock.

**Unit Size:**

13" x 17¼" x 4"  
(330 x 438 x 102 mm)

**Partition Opening:**

11⅜" x 15⅝"  
(290 x 400 mm)



0473

**RECESSED SANITARY NAPKIN DISPOSAL**

**1.5 gal.**  
WASTE CAPACITY  
(5.7 L)

**Model Option:**

**0473-1** Waste receptacle unit with lock.

**Unit Size:**

13" x 17¼" x 4¼"  
(330 x 438 x 108 mm)

**Wall Opening:**

11¼" x 15¾" x 4"  
(285 x 400 x 102 mm)



0473-A

**SURFACE MOUNTED END STALL  
SANITARY NAPKIN DISPOSAL**

**1.5 gal.**  
WASTE CAPACITY  
(5.7 L)

**Overall Dimensions:**

11" x 15¼" x 4"  
(279 x 387 x 102 mm)



0473-1A

**SURFACE MOUNTED END STALL SANITARY NAPKIN  
DISPOSAL WITH LOCK**

**1.5 gal.**  
WASTE CAPACITY  
(5.7 L)

**Overall Dimensions:**

11" x 15¼" x 4"  
(279 x 387 x 102 mm)



**6471**  
**SIMPLICITY™ RECESSED SANITARY NAPKIN DISPOSAL**

**1.4 gal.**  
WASTE CAPACITY  
(5.4 L)

**Unit Size:**  
10<sup>5</sup>/<sub>8</sub>" x 19<sup>5</sup>/<sub>8</sub>" x 4<sup>1</sup>/<sub>2</sub>"  
(270 x 498 x 114 mm)

**Wall Opening:**  
9<sup>1</sup>/<sub>8</sub>" x 18<sup>1</sup>/<sub>8</sub>" x 4"  
(232 x 460 x 102 mm)



**0852**  
**SURFACE MOUNTED SANITARY NAPKIN DISPOSAL**

**1.2 gal.**  
WASTE CAPACITY  
(4.5 L)

**Overall Dimensions:**  
7<sup>7</sup>/<sub>8</sub>" x 9<sup>1</sup>/<sub>16</sub>" x 4"  
(200 x 246 x 102 mm)



**20470**  
**ROVAL™ RECESSED SANITARY NAPKIN DISPOSAL**

**1.0 gal.**  
WASTE CAPACITY  
(3.7 L)

**Overall Dimensions:**  
12<sup>1</sup>/<sub>16</sub>" x 11" x 5<sup>1</sup>/<sub>16</sub>"  
(325 x 280 x 138 mm)



**20852**  
**ROVAL™ SURFACE MOUNTED SANITARY WASTE RECEPTACLE**

**1.0 gal.**  
WASTE CAPACITY  
(3.7 L)

**Overall Dimensions:**  
7<sup>1</sup>/<sub>4</sub>" x 10" x 3<sup>1</sup>/<sub>2</sub>"  
(185 x 253 x 89 mm)



# GRAB BARS

All grab bars are made in compliance with ADA guidelines and other international regulations for strength requirements. Various configurations are available in satin finish 18 gauge type 304 stainless steel (peened or smooth) and powder coated matte black or white finishes. Grab bars are heliarc welded.

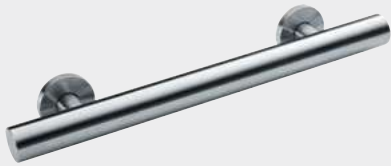

**OMARA GRAB BAR**  
**7801 Series** – 1½" (38 mm) O.D.

**CONCEALED**  
 MOUNTING STYLE

**7801-18** 18"  
**7801-24** 24"  
**7801-36** 36"  
**7801-42** 42"

**SUFFIX OPTION:**  
 P: Peened.



**SNAP FLANGE**  
**3700 Series** – 1¼" (32 mm) O.D.  
**3800 Series** – 1½" (38 mm) O.D.

**18** **CONCEALED**  
 GAUGE MOUNTING STYLE

**Model Options:**  
**3700-W** White.  
**3800-W** White.  
**3801-41** Matte Black.  
**3801-18-41** 18" Matte Black.  
**3801-24-41** 24" Matte Black.  
**3801-36-41** 36" Matte Black.  
**3801-42-41** 42" Matte Black.

**SUFFIX OPTION:**  
 P: Peened.



**EXPOSED MOUNTING**  
**3400 Series** – 1¼" (32 mm) O.D.  
**3500 Series** – 1½" (38 mm) O.D.

**EXPOSED**  
 MOUNTING STYLE

**SUFFIX OPTION:**  
 P: Peened.

## GRAB BAR CONFIGURATIONS

The following standard shapes are typical configurations. Grab bars can be custom designed and manufactured to meet any specific architectural requirement.

### Designers Note:

For a non-slip surface, specify suffix "P" (peened). When specifying grab bars, insert the configuration type numbers listed below into the double zeros at the end of the grab bar series number.

Example 1: A 1½" (38 mm) concealed 18" x 33" (460 x 840 mm) horizontal grab bar has a model number—3874. When a special size is needed, add suffix "M" plus the size, to the closest standard bars.

Example 2: A 1½" (38 mm) concealed 23" x 37" (585 x 940 mm) horizontal grab bar has a model number 3874-M2337.

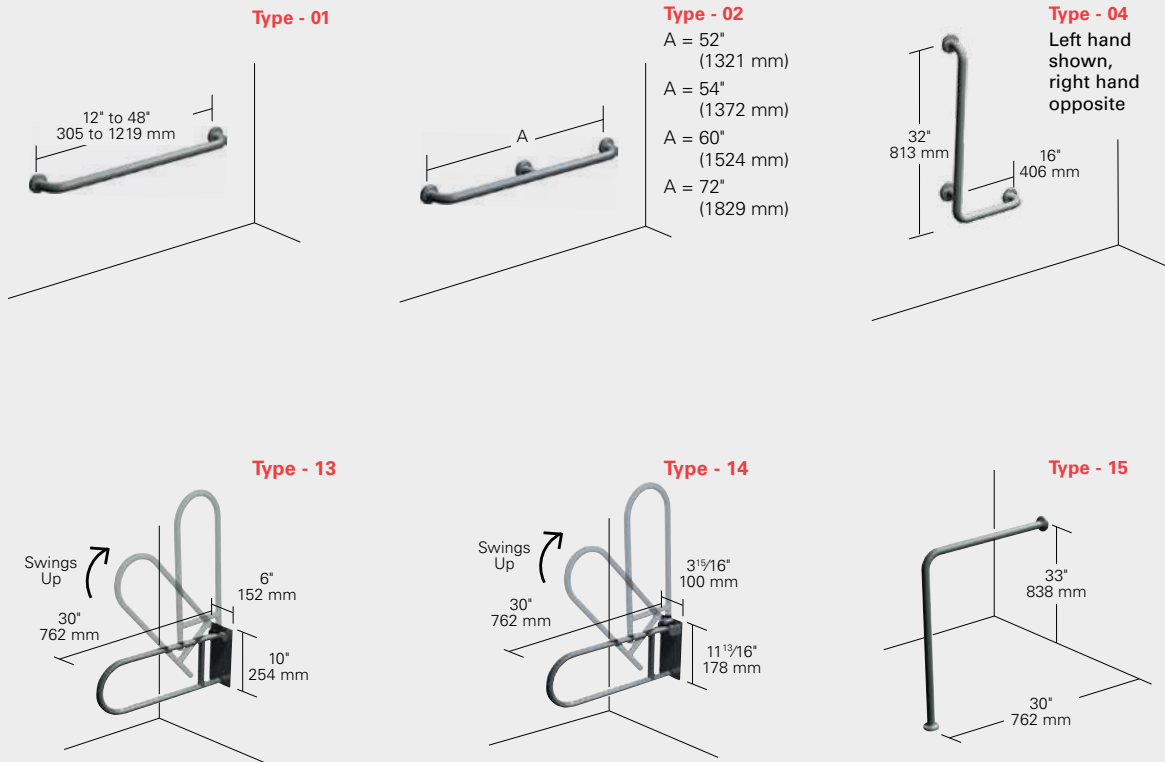

**Type - 20**



**Type - 24**

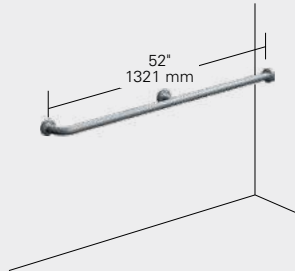

**Type - 33**  
Right hand shown,  
left hand opposite

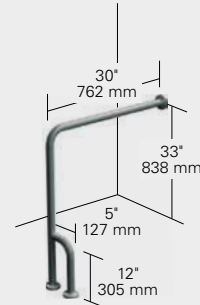

**Type - 34**

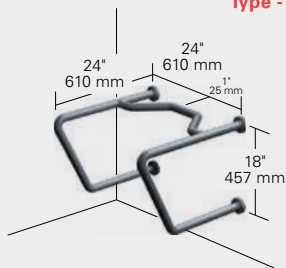

**Type - 51**

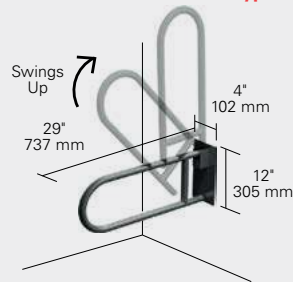

**Type - 75**



**Type - 50**

A = 24"  
(610 mm)  
B = 36"  
(914 mm)

**Type - 60**

A = 18"  
(457 mm)  
B = 30"  
(762 mm)

**Type - 56**

A = 36"  
(914 mm)  
B = 54"  
(1372 mm)

**Type - 74**

A = 18 1/8"  
(460 mm)  
B = 33 1/8"  
(841 mm)

**Type - 57**

A = 42"  
(1067 mm)  
B = 54"  
(1372 mm)

**Type - 54**

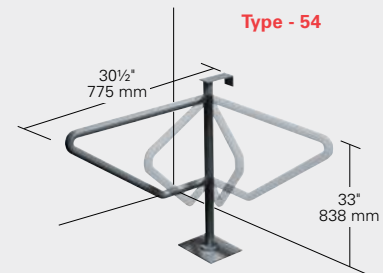



# HOOKS

The distinction is in the details for one of the smallest but not least important items inside the toilet. Matching designs for any of the aesthetic lines as well as functional applications.



**ROBE  
HOOK**



**TOWEL  
PIN**



**HAT AND  
COAT HOOK**



**7308**  
SINGLE ROBE HOOK

**SINGLE**  
HOOK



**7312**  
DOUBLE ROBE HOOK

**DOUBLE**  
HOOK



  
**7340-S**  
SINGLE ROBE HOOK –  
SATIN FINISH

**SINGLE**  
HOOK

**Unit Size:**  
2" x 2" x 2"  
(51 x 51 x 51 mm)



  
**7340-B**  
SINGLE ROBE HOOK –  
BRIGHT FINISH

**SINGLE**  
HOOK

**Unit Size:**  
2" x 2" x 2"  
(51 x 51 x 51 mm)



  
**7340-41**  
SINGLE ROBE HOOK –  
MATTE BLACK

**SINGLE**  
HOOK

**Unit Size:**  
2" x 2" x 2"  
(51 x 51 x 51 mm)



**7345-S**  
**DOUBLE ROBE HOOK – SATIN FINISH**

**DOUBLE**  
HOOK

**Overall Dimensions:**  
4" x 2" x 2"  
(102 x 51 x 51 mm)



**7345-B**  
**DOUBLE ROBE HOOK – BRIGHT FINISH**

**DOUBLE**  
HOOK

**Overall Dimensions:**  
4" x 2" x 2"  
(102 x 51 x 51 mm)



**7301-B**  
**TOWEL PIN**

**Model Option:**  
**7301-S** Towel pin with satin finish.

**Overall Dimensions:**  
2" x 2" x 3½"  
(51 x 51 x 89 mm)



**7382-S**  
**HAT AND COAT HOOK – SATIN FINISH**

**Overall Dimensions:**  
2" x 7" x 3"  
(51 x 178 x 76 mm)



**7382-B**  
**HAT AND COAT HOOK – BRIGHT FINISH**

**Overall Dimensions:**  
2" x 7" x 3"  
(51 x 178 x 76 mm)



**8425**  
**CLOTHES HOOK**

---



**0714**  
**COAT AND BUMPER HOOK, CHROME PLATED BRASS**

---

**WITH BUMPER**

**Overall Dimensions:**  
2<sup>3</sup>/<sub>16</sub>" (56 mm) diameter flange.  
Projects 1<sup>7</sup>/<sub>8</sub>" (48 mm).



**0751**  
**HEAVY-DUTY ROBE HOOK – CONCEALED,  
CHROME PLATED BRASS**

---

≤181 lbs.



**0751-A**  
**HEAVY-DUTY ROBE HOOK – EXPOSED,  
CHROME PLATED BRASS**

---

≤181 lbs.

**Overall Dimensions:**  
Exposed mounting, satin chrome plated brass, projects  
3<sup>1</sup>/<sub>4</sub>" (83 mm)



**0740-Z**  
**SINGLE ROBE HOOK, CHROME PLATED ZAMAK**

**SINGLE**  
HOOK

**Overall Dimensions:**  
2 1/8" x 1 7/16" x 2 1/8"  
(54 x 37 x 54 mm)



**0745-Z**  
**DOUBLE ROBE HOOK, CHROME PLATED ZAMAK**

**DOUBLE**  
HOOK

**Overall Dimensions:**  
2 3/16" x 1 7/16" x 1 29/64"  
(56 x 37 x 37 mm)



**0719**  
**DOOR BUMPER, CHROME PLATED ZAMAK**

**WITH BUMPER**

**Overall Dimensions:**  
Chrome plated Zamac 2 3/16" (56 mm) diameter flange.  
Projects 1 7/8" (48 mm).



**1306**  
**HEAVY-DUTY UTILITY HOOK, STAINLESS STEEL**



# TOILET TISSUE COMBINATION UNITS

Historically designed for disabled applications (ADA), as of late, particularly the horizontal combination units (picture on the left) have turned into a wider design trend.



**PARTITION  
MOUNTED  
COMBINATION  
UNITS**



**RECESSED  
COMBINATION  
UNITS**



**WALL  
MOUNTED  
UNITS**



**0487-R**  
**RECESSED ADA-COMPLIANT TOILET TISSUE AND SEAT COVER DISPENSER WITH WASTE DISPOSAL**

**500**  
 SEAT COVER CAPACITY

**2**  
 TOILET PAPER CAPACITY (ROLLS)

**.45 gal.**  
 WASTE CAPACITY (1.7 L)

**Model Options:**  
**0487-L** All components on opposite side.  
**0487-R-9** Surface mounted with a stainless steel collar.  
**0487-L-9** Surface mounted with a stainless steel collar, with all components on opposite side.

**Unit Size:**  
 28" x 14 1/4" x 4 1/4"  
 (711 x 362 x 108 mm)

**Wall Opening:**  
 26 1/2" x 12 7/8" x 4 1/4"  
 (673 x 327 x 108 mm)



**0482**  
**RECESSED SEAT COVER AND TOILET TISSUE DISPENSER WITH SANITARY DISPOSAL**

**1,000**  
 SEAT COVER CAPACITY

**2**  
 TOILET PAPER CAPACITY (ROLLS)

**1.3 gal.**  
 WASTE CAPACITY (4.9 L)

**Model Options:**  
**0482-R** Toilet tissue and receptacle on opposite side.  
**0483** Surface mounted with a stainless steel collar.

**Unit Size:**  
 17 7/8" x 30 5/8" x 4 1/4"  
 (441 x 778 x 108 mm)

**Partition Opening:**  
 15 1/2" x 28 7/8"  
 (394 x 733 mm)  
 adjustable for partitions in thickness from 1/2" to 2" (13 to 51 mm)



**0481**  
**PARTITION MOUNTED DUAL ACCESS SEAT COVER AND TOILET TISSUE DISPENSER WITH SANITARY DISPOSAL**

**1,000**  
 SEAT COVER CAPACITY

**4**  
 TOILET PAPER CAPACITY (ROLLS)

**1.3 gal.**  
 WASTE CAPACITY (4.9 L)

**Model Options:**  
**0481-HC** One side mounts flush.

**Unit Size:**  
 17 7/8" x 30 5/8" x 4 1/4"  
 (441 x 778 x 108 mm)

**Partition Opening:**  
 15 1/2" x 28 7/8"  
 (394 x 733 mm)  
 adjustable for partitions in thickness from 1/2" to 2" (13 to 51 mm)



**04813**  
**PARTITION MOUNTED DUAL ACCESS TOILET TISSUE DISPENSER WITH NAPKIN DISPOSAL**

**4**  
 TOILET PAPER CAPACITY (ROLLS)

**1.3 gal.**  
 WASTE CAPACITY (4.9 L)

**Model Options:**  
**04813-HC** One side mounts flush.  
**04823** Holds two rolls, for end-stall installation.  
**04833** Surface mounted with a stainless steel collar.

**Unit Size:**  
 17 7/8" x 20" x 4 1/4"  
 (441 x 508 x 108 mm)

**Partition Opening:**  
 15 1/2" x 18 1/4"  
 (394 x 464 mm)  
 adjustable for partitions in thickness from 1/2" to 2" (13 to 51 mm)



**0484**  
**PARTITION MOUNTED DUAL ACCESS**  
**SEAT COVER DISPENSER**

**1,000**

SEAT COVER  
CAPACITY

**4**

TOILET PAPER  
CAPACITY (ROLLS)

**Model Options:**

- 0484-HC** Mounts flush to partition.
- 0484-HCR** Dispenser on opposite side.
- 0484-R** Dispenser on opposite side.

**Unit Size:**

17<sup>3</sup>/<sub>8</sub>" x 30<sup>5</sup>/<sub>8</sub>" x 4<sup>1</sup>/<sub>2</sub>"  
 (441 x 778 x 114 mm)

**Wall Opening:**

15<sup>1</sup>/<sub>2</sub>" x 28<sup>7</sup>/<sub>8</sub>" x 1/2" to 2"  
 (394 x 733 x 13 to 51 mm)



**0485**  
**RECESSED SEAT COVER AND TOILET TISSUE DISPENSER**

**1,000**

SEAT COVER  
CAPACITY

**2**

TOILET PAPER  
CAPACITY (ROLLS)

**1.3 gal.**

WASTE CAPACITY  
(4.9 L)

**Model Options:**

- 0486** Surface mounted with a stainless steel collar.

**Unit Size:**

17<sup>3</sup>/<sub>8</sub>" x 30<sup>5</sup>/<sub>8</sub>" x 4<sup>1</sup>/<sub>2</sub>"  
 (441 x 778 x 114 mm)

**Wall Opening:**

15<sup>3</sup>/<sub>4</sub>" x 29" x 4"  
 (400 x 737 x 102 mm)



**04822**  
**RECESSED TOILET TISSUE DISPENSER/  
 NAPKIN DISPOSAL**

**2**

TOILET PAPER  
CAPACITY (ROLLS)

**1.3 gal.**

WASTE CAPACITY  
(4.9 L)

**Unit Size:**

17<sup>1</sup>/<sub>4</sub>" x 12<sup>3</sup>/<sub>4</sub>" x 4<sup>1</sup>/<sub>4</sub>"  
 (438 x 324 x 108 mm)

**Wall Opening:**

15<sup>3</sup>/<sub>4</sub>" x 11<sup>1</sup>/<sub>6</sub>" x 4"  
 (400 x 283 x 102 mm)



**048234**  
**RECESSED MULTI-ROLL TOILET TISSUE DISPENSER**

**4**

TOILET PAPER  
CAPACITY (ROLLS)

**Unit Size:**

17<sup>3</sup>/<sub>8</sub>" x 20" x 4<sup>1</sup>/<sub>4</sub>"  
 (441 x 508 x 108 mm)

**Wall Opening:**

15<sup>3</sup>/<sub>4</sub>" x 18<sup>3</sup>/<sub>8</sub>" x 4"  
 (400 x 467 x 102 mm)

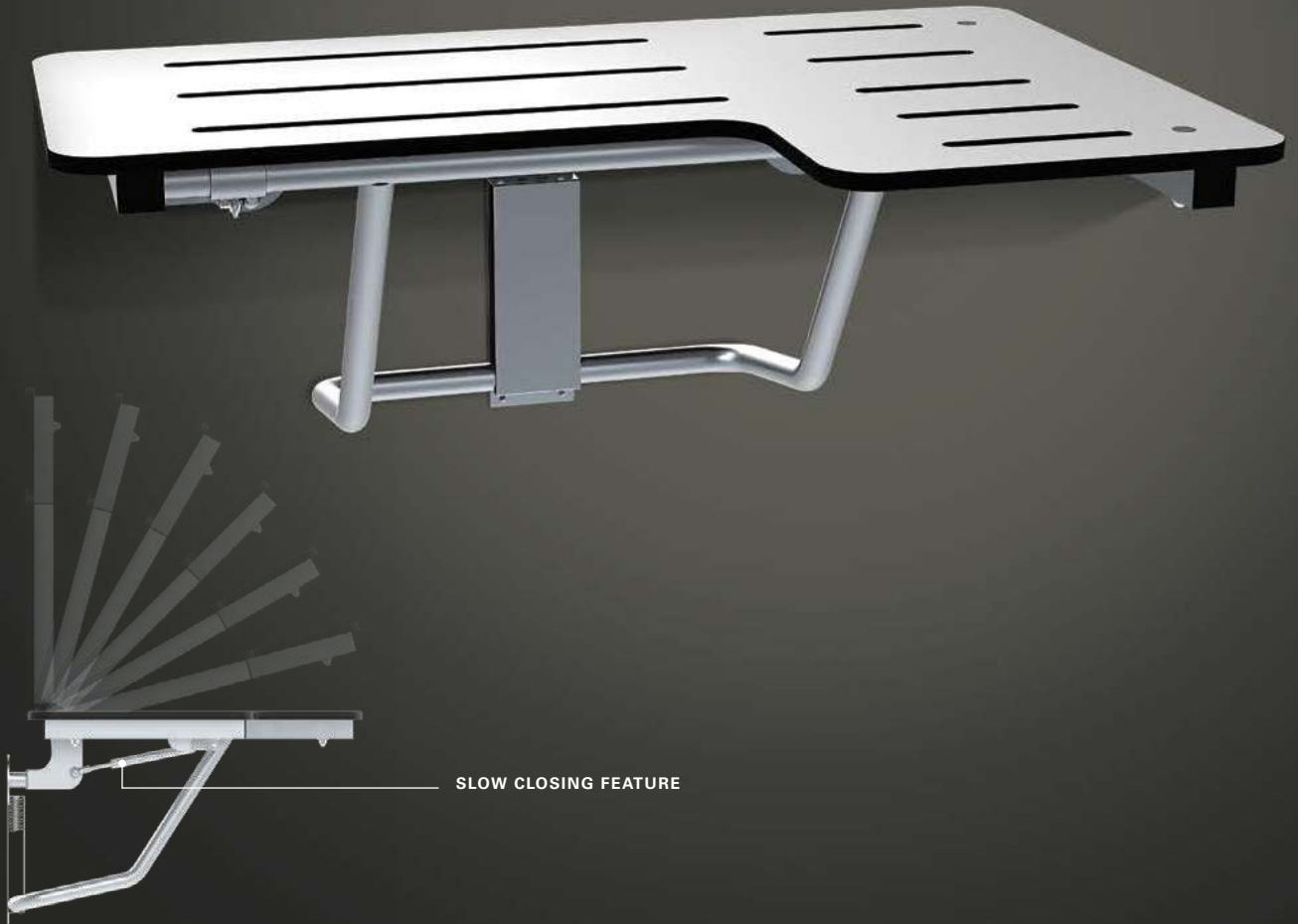

SLOW CLOSING FEATURE

# SHOWER/TUB ACCESSORIES

A full range of shower and tub accessories that show attention to details.



**SHOWER/TUB ACCESSORIES**  
ALL STAINLESS STEEL IS TYPE 304 WITH SATIN FINISH,  
UNLESS OTHERWISE NOTED.



**SOAP  
DISHES**

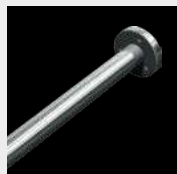



**SHOWER  
CURTAIN  
ROD**



**SHOWER  
CURTAIN**





  
**1204-2**  
**EXTRA HEAVY-DUTY SHOWER CURTAIN ROD**

---

**SURFACE MOUNTED**

**Model Option:**  
**1204-1** Flanges for shower curtain rod, end flanges.  
**1204-C** Ceiling mounted shower rod support.  
**1214** 20 gauge, 1" (25 mm) diameter rod. Available in lengths up to 72" (1829 mm).







  
**1201-A**  
**CURVED SHOWER CURTAIN ROD WITH MOUNTING BRACKETS AND FLANGES IN CHROME PLATED ZAMAK**

---

**CURVED ROD**

**Model Option:**  
**1201-B** Curved shower curtain rod with mounting brackets for opposite walls.  
**1201-41** Matte Black.







  
**1224**  
**CONCEALED MOUNTING SHOWER CURTAIN ROD WITH FLANGES IN CHROME PLATED BRASS**

---

**SURFACE MOUNTED**

**Model Option:**  
**1224-C** Ceiling mounted rod support.  
**1200-V** White vinyl shower curtain.  
**1200-SHU** Shower curtain hook.





**0398**  
**RECESSED HEAVY-DUTY SOAP DISH AND BAR**

---

**Model Options:**  
**0399** Same as 0398, but includes kit for installing in cement wall.  
**0400** Without bar.  
**0401** Same as 0400, but includes kit for installing in cement wall.

**Overall Dimensions:**  
 7 1/8" x 5" x 4"  
 (181 x 127 x 102 mm)

**Wall Opening:**  
 6 1/8" x 4 1/8" x 4"  
 (156 x 105 x 102 mm)





  
**7404-S**  
**RECESSED SOAP DISH**

---

**Model Option:**  
**7404-B** Bright stainless steel.

**Overall Dimensions:**  
 6 1/4" x 6 5/8" x 2"  
 (159 x 160 x 51 mm)

**Wall Opening:**  
 5 1/2" x 5 1/2" x 2"  
 (140 x 140 x 51 mm)





  
**7410-B**  
**RECESSED SOAP DISH AND BAR**

---

**Model Option:**  
**7410-S** Satin stainless steel.

**Overall Dimensions:**  
 6 7/16" x 6 1/4" x 3"  
 (160 x 159 x 76 mm)

**Wall Opening:**  
 5 1/2" x 5 1/2" x 2"  
 (140 x 140 x 51 mm)



0721-Z  
SOAP DISH

CHROME SURFACE  
PLATED ZAMAC MOUNTED

Overall Dimensions:  
4" x 1 1/2" x 3 1/4"  
(102 x 38 x 83 mm)



0720-Z  
SOAP DISH WITH DRAIN HOLES

CHROME SURFACE  
PLATED ZAMAC MOUNTED

Overall Dimensions:  
4" x 1 1/2" x 3 1/4"  
(102 x 38 x 83 mm)



7320  
SOAP DISH

SURFACE  
MOUNTED

Model Options:  
0721-Z Fabricated from triple chrome plated rust-resistant Zamac.  
7320-B Bright stainless steel.  
7320-S Satin stainless steel.

Overall Dimensions:  
4 1/4" x 2" x 4"  
(108 x 51 x 102 mm)



7335  
TOOTHBRUSH AND TUMBLER HOLDER

SURFACE  
MOUNTED

Model Options:  
0735-Z Fabricated from triple chrome plated rust-resistant Zamac.  
7335-B Bright stainless steel.  
7335-S Satin stainless steel.

Overall Dimensions:  
4 1/4" x 2" x 4"  
(108 x 51 x 102 mm)



**1200-SHU**  
SHOWER CURTAIN HOOK

**.098"**  
DIAMETER

**Overall Dimensions:**  
1 3/16" x 2 5/16"  
(40 x 67 mm)



**1200-V**  
VINYL SHOWER CURTAIN

**ANTI-BACTERIAL**



**8203**  
COMPACT FOLDING SEAT

**500 lbs.    SOLID**  
SUPPORT LOAD    PHENOLIC SEAT

**Model Options:**  
**8204** Seat is sponge cushion covered with off-white Naugahyde® mounted on 1/2" (13 mm) thick marine grade plywood.  
**8207** Seat is fabricated of stainless steel slats, satin finish.



**8208-R**  
FOLDING SHOWER SEAT  
FABRICATED STEEL SLATS,  
SATIN FINISH

**500 lbs.**  
SUPPORT LOAD

**Model Option:**  
**8208-L** Left hand seat.



**0010**  
CORNER SHOWER SEAT

**300 lbs.    CORNER**  
SUPPORT LOAD    INSTALLATION

**Overall Dimensions:**  
15 3/4" x 15 3/4"  
(400 x 400 mm)



**8358**  
FOLDING TUB SEAT

**SOLID    SURFACE**  
PHENOLIC SEAT    MOUNTED



 **8206-L**  
FOLDING SHOWER SEAT

**500 lbs.**  
SUPPORT LOAD

**SOLID**  
PHENOLIC SEAT

**Model Options:**  
**8206-R** Right hand seat.  
**8205-L** Left hand seat with cushion covered in off-white Naugahyde.  
**8205-R** Right hand seat with cushion covered in off-white Naugahyde.



 **8206-SC-L**  
SLOW CLOSE FOLDING SHOWER SEAT

**500 lbs.**  
SUPPORT LOAD

**SOLID**  
PHENOLIC SEAT

**Model Option:**  
**8206-SC-R** Right hand seat.



 **8209**  
RECTANGULAR PHENOLIC FOUR-LEG  
FOLD-UP SHOWER BENCH

**1250 lbs.**  
SUPPORT LOAD

**WALL**  
MOUNTED /  
FLOOR STANDING

**SOLID**  
PHENOLIC SEAT



 **8202**  
L-SHAPED PHENOLIC FOUR-LEG FOLD-UP SHOWER SEAT

**1250 lbs.**  
SUPPORT LOAD

**WALL**  
MOUNTED /  
FLOOR STANDING

**SOLID**  
PHENOLIC SEAT



**7385-S**  
TOWEL RING

**SURFACE**  
MOUNTED

**Model Options:**  
7385-41 Matte Black.  
7385-B Bright stainless steel.



**7306**  
TOWEL RING

**SURFACE**  
MOUNTED



**0760-Z**  
SQUARE TOWEL BAR

**CHROME** **SURFACE** **SQUARE**  
PLATED ZAMAC MOUNTED STYLE



**7360-S**  
SQUARE TOWEL BAR

**SURFACE** **SQUARE**  
MOUNTED STYLE

**Model Option:**  
7360-B Bright finish.



**7380-S**  
SQUARE TOWEL BAR

**SURFACE** **SQUARE**  
MOUNTED STYLE

**Model Option:**  
7380-B Bright finish.



**7355**  
**TOWEL BAR-ROUND**

**SURFACE**      **ROUND**  
MOUNTED      STYLE

**Model Options:**  
7355-24-41 24" Matte Black.  
7355-B Bright stainless steel.  
7355-S Satin stainless steel.



**0755-SS**  
**HEAVY-DUTY STAINLESS STEEL TOWEL BAR**

**SURFACE**      **ROUND**  
MOUNTED      STYLE

**Model Option:**  
0755-Z Triple chrome plated rust proof Zamac brackets.  
Triple chrome plated steel tubing.



**7307-18**  
**ROUND TOWEL BAR**

**SURFACE**      **ROUND**  
MOUNTED      STYLE

**Model Option:**  
7307-24 Same as 7307-18, but 24"  
(610 mm) in length, 5/8" (16 mm) DIA.



**7311-B**  
**TOWEL SHELF WITH TOWEL BAR**

**SURFACE**  
MOUNTED



## DETAILS



### MINIMALISTIC, CONTEMPORARY, AND CLASSIC

Timeless design put into machined precision.



### LEED®-FRIENDLY

The robust construction made of type 304 stainless steel is LEED®-friendly and fits our sensibility about longer lifecycle building designs.



### HUMBLE LOOK, RICH FUNCTION

Withdrawn impressions for sleek complementation.

# HOSPITALITY ACCESSORIES

A wide range of towel bars and racks, clothes hooks, shelving, holders, and many more for the hospitality sector.

**HOSPITALITY ACCESSORIES**  
ALL STAINLESS STEEL IS TYPE 304 WITH SATIN FINISH,  
UNLESS OTHERWISE NOTED.



**SINGLE  
TOILET  
PAPER  
ROLL  
HOLDER**



**SHELF  
WITH  
HANGER  
ROD**

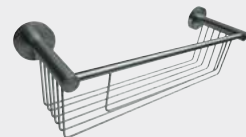

**SUNDRIES  
SHELF**



**7308**  
**SINGLE ROBE HOOK**

**SINGLE**  
HOOK



**7312**  
**DOUBLE ROBE HOOK**

**DOUBLE**  
HOOK



  
**7314**  
**SINGLE TOILET PAPER**  
**ROLL HOLDER**

**SURFACE**  
MOUNTED

**Overall Dimensions:**  
5<sup>7</sup>/<sub>16</sub>" x 3<sup>3</sup>/<sub>8</sub>" x 2<sup>3</sup>/<sub>16</sub>"  
(131 x 86 x 56 mm)



  
**7317**  
**COVERED WASTE RECEPTACLE**

**2.0 gal.** **FLOOR**  
**WASTE CAPACITY** **STANDING**  
(7.6 L)

**Model Option:**  
**7317-S** Satin stainless steel finish.

**Overall Dimensions:**  
8<sup>7</sup>/<sub>32</sub>" DIA x 12<sup>3</sup>/<sub>4</sub>"  
(210 DIA x 324 mm)



**7314-H**  
SINGLE TOILET PAPER ROLL HOLDER WITH HOOD

**SURFACE**  
MOUNTED

**Overall Dimensions:**  
5<sup>1</sup>/<sub>4</sub>" x 5" x 2<sup>3</sup>/<sub>16</sub>"  
(133 x 127 x 65 mm)



**7316**  
SPARE TOILET PAPER HOLDER

**SURFACE**  
MOUNTED

**Overall Dimensions:**  
3<sup>35</sup>/<sub>64</sub>" DIA x 6<sup>5</sup>/<sub>8</sub>"  
(90 DIA x 167 mm)



**0640**  
FRAMELESS MIRROR WITH LED BACKLIGHT

**5/32"** **FRAMELESS** **SURFACE**  
PLATE GLASS MOUNTED

**Model Options:**  
**0640-2436** 24" x 36" (640 x 914 mm)  
**0640-3036** 30" x 36" (762 x 914 mm)  
**0640-4836** 48" x 36" (1219 x 914 mm)  
**0640-6036** 60" x 36" (1524 x 914 mm)

See chart for standard sizes on page 78.



**0641**  
FRAMELESS MIRROR WITH FROSTED BORDER AND LED BACKLIGHT

**5/32"** **FRAMELESS** **SURFACE**  
PLATE GLASS MOUNTED

**Model Options:**  
**0641-2436** 24" x 36" (640 x 914 mm)  
**0641-3036** 30" x 36" (762 x 914 mm)  
**0641-4836** 48" x 36" (1219 x 914 mm)  
**0641-6036** 60" x 36" (1524 x 914 mm)

See chart for standard sizes on page 78.



**7387**  
**SURFACE MOUNTED TOILET BRUSH AND HOLDER**

**WALL**  
**MOUNTED**



**0712**  
**SURFACE-MOUNTED RETRACTABLE CLOTHES LINE, BRIGHT FINISH**

**72"** **RETRACTABLE**  
**VINYL COVERED**  
**CORD**



**7383**  
**SURFACE MOUNTED TOWEL SHELF WITH HANGER ROD**

**35.3 lb.**  
**WEIGHT CAPACITY**

**Overall Dimensions:**  
23<sup>3</sup>/<sub>8</sub>" x 3<sup>1</sup>/<sub>2</sub>" x 8<sup>19</sup>/<sub>16</sub>"  
(600 x 89 x 227 mm)

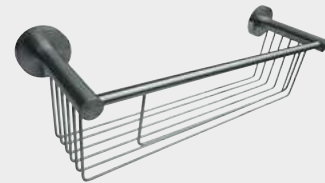

**7381**  
**SURFACE MOUNTED SUNDRIES SHELF**

**11 lb.**  
**WEIGHT CAPACITY**

**Overall Dimensions:**  
12<sup>1</sup>/<sub>8</sub>" x 4<sup>7</sup>/<sub>16</sub>" x 3<sup>39</sup>/<sub>64</sub>"  
(372 x 114 x 90 mm)



  
**7306**  
TOWEL RING

**SURFACE**  
MOUNTED



  
**0785-Z**  
TOWEL RING, ZAMAK

**SURFACE**  
MOUNTED

**Overall Dimensions:**  
6<sup>3</sup>/<sub>8</sub>" x 1<sup>5</sup>/<sub>8</sub>"  
(162 x 41 mm)



  
**7322**  
SURFACE MOUNTED SOAP BASKET

**10 lb.**  
WEIGHT CAPACITY

**Overall Dimensions:**  
11<sup>19</sup>/<sub>32</sub>" x 2<sup>9</sup>/<sub>32</sub>" x 6<sup>1</sup>/<sub>2</sub>"  
(291 x 58 x 165 mm)



**7307-18**  
ROUND TOWEL BAR

**SURFACE**  
MOUNTED

**Model Option:**  
**7307-24** Same as 7307-18, but 24"  
(610 mm) in length, 5/8" (16 mm) DIA.



**0259-SS**  
**RECESSED FACIAL TISSUE DISPENSER, SATIN FINISH**

**SMOOTH**  
DISPENSING  
SLOT

**Model Option:**  
**0259-B** Bright stainless steel.

**Overall Dimensions:**  
11<sup>1</sup>/<sub>8</sub>" x 6<sup>3</sup>/<sub>8</sub>" x 2<sup>1</sup>/<sub>4</sub>"  
(302 x 162 x 57 mm)



**0258-SS**  
**SURFACE MOUNTED FACIAL TISSUE DISPENSER**

**Overall Dimensions:**  
10<sup>1</sup>/<sub>4</sub>" x 5<sup>5</sup>/<sub>16</sub>" x 2<sup>3</sup>/<sub>16</sub>"  
(260 x 135 x 55 mm)



**1201-A**  
**CURVED SHOWER CURTAIN ROD WITH MOUNTING  
BRACKETS AND FLANGES IN CHROME PLATED ZAMAK**

**CURVED**      **WALL**  
**ROD**            **MOUNTED**

**Model Option:**  
**1201-B** Curved shower curtain rod with mounting brackets  
for opposite walls.  
**1201-41** Matte Black.



**8091**  
ASH TRAY (FLIP-TYPE)

**SURFACE**  
MOUNTED

**Overall Dimensions:**  
4<sup>3</sup>/<sub>4</sub>" x 3<sup>3</sup>/<sub>4</sub>" x 1<sup>1</sup>/<sub>4</sub>"  
(120 x 90 x 32 mm)



**0711-B**  
BOTTLE OPENER

**SURFACE**  
MOUNTED

**Overall Dimensions:**  
2" x 2<sup>1</sup>/<sub>4</sub>" x 1<sup>1</sup>/<sub>16</sub>"  
(51 x 57 x 27 mm)



**0002-SM**  
STAINLESS STEEL PAPER CUP DISPENSER, BRIGHT FINISH

**SURFACE**  
MOUNTED

**Overall Dimensions:**  
3" Diameter x 15"  
(76 x 381 mm)

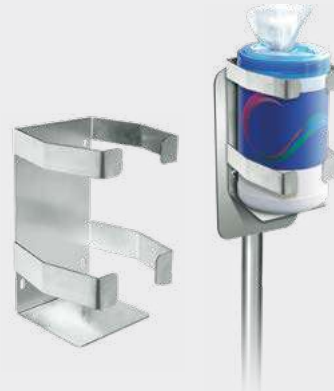

**0502**  
WALL MOUNTED WIPES DISPENSER HOLDER,  
SATIN FINISH

**MANUAL**  
DISPENSING

**Overall Dimensions:**  
5<sup>29</sup>/<sub>64</sub>" x 8" x 5"  
(139 x 203 x 127 mm)



## DETAILS



### ADA ACCESSIBILITY STANDARD COMPLIANT

Our healthcare accessories are engineered to comply with the standards set forth by the Americans with Disabilities Act for accessibility and safety.



### CYLINDER LOCK

The design of our cylinder locks allows for the removal of the cylinder for sterilizing or autoclaving when necessary.



### CONVENIENT PASSAGE

Our specimen pass box and cabinet enables easy access and safe handling of specimens from patient area to laboratory.



### ADJUSTABLE SHELVES

The design of our cabinets offers flexibility with adjustable shelves for ease in storage and use.

# HEALTHCARE ACCESSORIES

From grab bars and a slow close shower seat to glove dispensers, security cabinets, and hazardous waste disposals.



**RECESSED  
STAINLESS  
STEEL MEDICINE  
CABINET**



**RECESSED  
SHARPS  
DISPOSAL  
CABINET**



**TURNTABLE  
SPECIMEN  
PASS BOX**



**0952**  
**RECESSED STAINLESS STEEL MEDICINE CABINET**

**ADJUSTABLE**  
 SHELVES

**Overall Dimensions:**  
 18¼" x 24¼" x 4½"  
 (464 x 616 x 114 mm)

**Wall Opening:**  
 16" x 22¾" x 3½"  
 (406 x 578 x 89 mm)

**Model Option:**  
**0952-B** Larger than 0952.

**Overall Dimensions:**  
 24" x 26" x 4⅞"  
 (610 x 660 x 124 mm)

**Wall Opening:**  
 21¾" x 24½" x 3½"  
 (550 x 620 x 89 mm)



**0953**  
**SURFACE MOUNTED STAINLESS STEEL MEDICINE CABINET**

**ADJUSTABLE**  
 SHELVES

**Overall Dimensions:**  
 18¼" x 24¼" x 4¾"  
 (464 x 616 x 121 mm)

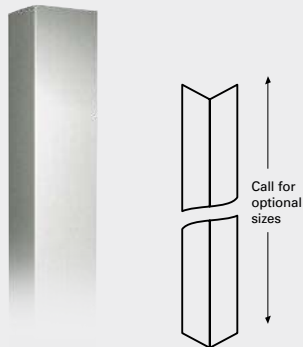

**0533 SERIES**  
**CORNER GUARD**

**SURFACE**  
 MOUNTED

**1) CHOOSE EDGE AND MOUNTING STYLE:**

0533-1 Beveled w/ Adhesive      0533-3 Straight w/ Adhesive  
 0533-2 Beveled w/ Mounting Holes      0533-4 Straight w/ Mounting Holes

**2) ADD PREFIX FOR GAUGE:**

1 (16 Gauge) or 2 (18 Gauge)  
 Ex: 0533-3-2 straight edges with adhesive mounting, 18 gauge

**Overall Dimensions:**  
 48" x 4¼" x 4¼" (1219 x  
 108 x 108 mm)

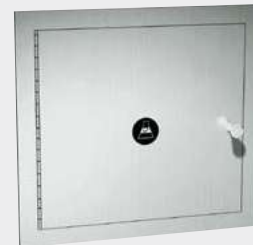

**8154**  
**RECESSED PASS-THROUGH SPECIMEN CABINET**

**CYLINDER**  
 LOCK

**Model Options:**  
**8155** Extension sleeve and flange for recessed specimen pass-through cabinet.  
**8156** Same as 8154 including 8155 extension sleeve.



**8340**  
**RECESSED MEDICINE CABINET, POWDER COATED STEEL,  
 MIRROR FRAME STAINLESS STEEL**

**1/4" ADJUSTABLE**  
 PLATE GLASS SHELVES

**Overall Dimensions:** 18 1/4" x 24 1/4" x 4 7/8"  
 (465 x 615 x 120 mm)  
**Wall Opening:** 16" x 22 3/4" x 3 1/2"  
 (406 x 578 x 89 mm)

**Model Options:**  
**8338** Smaller and has two adjustable white baked enamel steel shelves.

**Overall Dimensions:** 14 1/8" x 20 3/16" x 5"  
 (359 x 513 x 125 mm)  
**8339** Larger than 8338.  
 16 3/16" x 22 3/16" x 5"  
 (411 x 564 x 127 mm)



**0515**  
**TURNTABLE SPECIMEN PASS BOX**

**RECESSED CYLINDER**  
 LOCK



**0350**  
**SURGICAL SOAP DISPENSER,  
 CHROME PLATED BRASS BRACKET**

**16 oz. SURFACE**  
 CAPACITY MOUNTED

**Overall Dimensions:**  
 3 3/8" x 6 1/2" x 5 1/8"  
 (86 x 165 x 130 mm)



**0349**  
**FOOT OPERATED SURGICAL SOAP DISPENSER,  
 TYPE 316 STAINLESS STEEL SPOUT**

**32 oz. SURFACE FOOT**  
 CAPACITY MOUNTED OPERATED

**Overall Dimensions:** 4 1/4" x 12 3/4" x 9"  
 (108 x 324 x 229 mm)  
**Spout Projection:**  
 9" (229 mm) from wall



**0815**  
**FLOOR STANDING FOOT  
OPERATED WASTE RECEPTACLE**

**8 gal.**      **FOOT**  
WASTE CAPACITY      OPERATED  
(30.7 L)

**Overall Dimensions:**  
10<sup>3</sup>/<sub>4</sub>" x 20<sup>15</sup>/<sub>16</sub>" x 10"  
(273 x 531 x 254 mm)



**0548**  
**RECESSED SHARPS DISPOSAL  
CABINET**

**Model Option:**  
**0548-9** Surface mounted with a  
stainless steel collar.

**Overall Dimensions:**  
13<sup>3</sup>/<sub>4</sub>" x 19<sup>1</sup>/<sub>16</sub>" x 5<sup>1</sup>/<sub>4</sub>"  
(349 x 486 x 133 mm)

**Wall Opening:**  
12<sup>1</sup>/<sub>8</sub>" x 17<sup>3</sup>/<sub>4</sub>" x 5"  
(308 x 451 x 127 mm)



**0551**  
**RECESSED BEDPAN AND URINAL  
BOTTLE CABINET**

**ADJUSTABLE**  
SHELVES

**Model Option:**  
**0558-1** Recessed bedpan and wash  
basin cabinet.

**Overall Dimensions:**  
15" x 28" x 5<sup>1</sup>/<sub>4</sub>"  
(381 x 711 x 133 mm)

**Wall Opening:**  
13<sup>3</sup>/<sub>8</sub>" x 26<sup>1</sup>/<sub>2</sub>" x 5<sup>3</sup>/<sub>8</sub>"  
(340 x 670 x 140 mm)



**0501-X**  
SURFACE MOUNTED SURGICAL GLOVE DISPENSER

**SNAG-FREE**  
DISPENSING

**Model Options:**

- 0501-1** Dispenser for 1 box.
- 0501-2** Dispenser for 2 boxes.
- 0501-3** Dispenser for 3 boxes.
- 0501-4** Dispenser for 4 boxes.



**0511**  
SURFACE MOUNTED BULK DISPENSER, SMALL

**SMALL**  
FOOTPRINT

**Overall Dimensions:**  
12<sup>5</sup>/<sub>64</sub>" x 11" x 5<sup>1</sup>/<sub>2</sub>"  
(307 x 279 x 140 mm)

**Model Option:**  
**0512** Large bulk dispenser.

**Overall Dimensions:**  
12<sup>5</sup>/<sub>64</sub>" x 17" x 5<sup>1</sup>/<sub>2</sub>"  
(307 x 431 x 140 mm)



**0557**  
SURFACE MOUNTED BEDPAN RACK

**Model Options:**

- 0556** Surface mounted bedpan and urinal rack.
- 0559** Surface mounted double bedpan rack. Similar to 0556 but designed to hold two conventional sized bedpans.

**Overall Dimensions:**  
12" x 11" x 4<sup>7</sup>/<sub>8</sub>"  
(305 x 279 x 124 mm)



**0198-MH**  
SAFE-DRI™ MENTAL HEALTH APPROVED RECESSED  
HIGH-SPEED HAND DRYER

**66 dBA**      **ANTI-**  
**NOISE LEVEL**      **LIGATURE**

**Noise Level:**  
66 dBA

**Unit Size:**  
12<sup>9</sup>/<sub>64</sub>" x 15<sup>3</sup>/<sub>4</sub>" x 5<sup>1</sup>/<sub>16</sub>"  
(320 x 400 x 140 mm)

**Wall Opening:**  
12<sup>1</sup>/<sub>4</sub>" x 15<sup>3</sup>/<sub>16</sub>" x 5<sup>1</sup>/<sub>4</sub>"  
(311 x 386 x 133 mm)



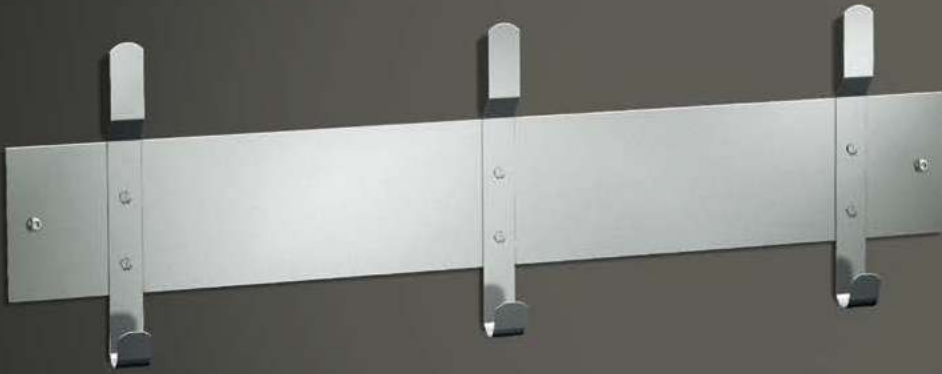

# **CUSTODIAL** ACCESSORIES

Our one-piece constructed custodial accessories—with various configurations of mop and broom holders and utility hooks.



**UTILITY  
HOOKS**



**1307-3**  
**UTILITY HOOK STRIP**  
**WITH 3 HOOKS**

---

**SURFACE**  
MOUNTED

**Model Options:**  
**1307-4** With 4 hooks 36"  
(914 mm) long.  
**1307-5** With 5 hooks 46"  
(1168 mm) long.  
**1307-6** With 6 hooks 56"  
(1422 mm) long.



**1308-3**  
**SHELF WITH 4 UTILITY HOOKS**  
**AND 3 MOP HOLDERS STRIP**

---

**SURFACE**  
MOUNTED

**Model Option:**  
**1308-4** 4 mop holders/5 utility  
hooks, 44" (1118 mm) long.



**1306**  
**HEAVY-DUTY UTILITY HOOK**

---

**SURFACE**  
MOUNTED

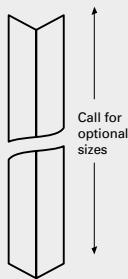

**0533 SERIES**  
**CORNER GUARD**

**SURFACE**  
MOUNTED

**1) CHOOSE EDGE AND MOUNTING STYLE:**

- 0533-1 Beveled w/ Adhesive
- 0533-2 Beveled w/ Mounting Holes
- 0533-3 Straight w/ Adhesive
- 0533-4 Straight w/ Mounting Holes

**2) ADD PREFIX FOR GAUGE:**

1 (16 Gauge) or 2 (18 Gauge)  
Ex: 0533-3-2 straight edges with adhesive mounting, 18 gauge

**Overall Dimensions:**  
48" x 4 1/4" x 4 1/4"  
(1219 x 108 x 108 mm)



**8215-5**  
**MOP AND BROOM RACKS**

**SURFACE**  
MOUNTED

**Model Options:**  
**8215-3** 3 holders, 26" (660 mm) long.  
**8215-4** 4 holders, 36" (914 mm) long.



**1315-4**  
**UTILITY SHELF WITH DRYING ROD, 4 MOP HOLDERS, AND 3 RAG HOOKS**

**SURFACE**  
MOUNTED

**Model Options:**  
**1315-3** 3 mop holders/2 rag hooks, 30" (762 mm) long.  
**1315-6** 6 mop holders/5 rag hooks, 48" (1219 mm) long.



# SECURITY ACCESSORIES

For settings with high security requirements. Features include design for contraband detection and clothes hooks that release when excessively loaded to deter self-harm actions.

**SECURITY ACCESSORIES**  
**ALL STAINLESS STEEL IS TYPE 304 WITH SATIN FINISH,**  
**UNLESS OTHERWISE NOTED.**



**HAND  
DRYERS**



**MIRRORS**



**CLOTHES  
HOOKS**



**0198-MH**  
SAFE-DRI™ MENTAL HEALTH  
RECESSED HIGH-SPEED  
HAND DRYER

**66 dBA**      **ANTI-**  
NOISE LEVEL      LIGATURE

**Noise Level:**  
66 dBA

**Unit Size:**  
12<sup>5</sup>/<sub>8</sub>" x 15<sup>3</sup>/<sub>4</sub>" x 5<sup>1</sup>/<sub>16</sub>"  
(320 x 400 x 140 mm)

**Wall Opening:**  
12<sup>1</sup>/<sub>4</sub>" x 15<sup>3</sup>/<sub>16</sub>" x 5<sup>1</sup>/<sub>4</sub>"  
(311 x 386 x 133 mm)



**128-1**  
BOOK SHELF/CLOTHES HOOK -  
FRONT MOUNT

**ANTI-**  
LIGATURE

**Overall Dimensions:**  
18" x 11" x 8"  
(457 x 279 x 203 mm)



**120**  
CLOTHES HOOK - FRONT MOUNT

**ANTI-**  
LIGATURE

**Overall Dimensions:**  
3" x 5" x 3<sup>1</sup>/<sub>16</sub>"  
(76 x 127 x 78 mm)

Special "closure plate" for security applications



**165**  
GRAB BAR

**ANTI-**  
LIGATURE

**MODEL OPTIONS:**

Front Mounted	Length
159	18" (457)
162	30" (762)
164	36" (914)
165	24" (610)
167	42" (1067)
169	48" (1219)



**110-1**  
SQUARE RECESSED TOILET  
TISSUE HOLDER - REAR MOUNT

**1**  
TOILET PAPER  
CAPACITY (ROLLS)

**Model Option:**  
**110-13** Front mounted holder.



**123**  
SQUARE CLOTHES HOOK -  
FRONT MOUNT

**ANTI-**  
LIGATURE

**Overall Dimensions:**  
4<sup>1</sup>/<sub>4</sub>" x 4<sup>1</sup>/<sub>4</sub>" x 2<sup>1</sup>/<sub>4</sub>"  
(108 x 108 x 57 mm)



**101-14**  
SECURITY FRAMED MIRROR –  
CHASE MOUNT

**15 YEAR**  
WARRANTY

**Overall Dimensions:**  
12" x 16" x 5/8"  
(305 x 406 x 16 mm)



**105-14**  
SECURITY FRAMED MIRROR –  
FRONT MOUNT

**15 YEAR**  
WARRANTY

**Overall Dimensions:**  
12" x 16" x 5/8"  
(305 x 406 x 16 mm)



**127**  
CLOTHES/TOWEL HOOK STRIP –  
FRONT MOUNT

**ANTI-**  
LIGATURE

**Overall Dimensions:**  
18" x 5 1/2" x 3"  
(457 x 140 x 76 mm)



**129**  
CLOTHES/TOWEL HOOK STRIP –  
FRONT MOUNT

**ANTI-**  
LIGATURE

**Overall Dimensions:**  
18" x 5 1/2" x 2 1/4"  
(457 x 140 x 57 mm)



**140**  
RECESSED SOAP DISH–  
REAR MOUNT

**Overall Dimensions:**  
7 3/8" x 6" x 3"  
(187 x 152 x 76 mm)

**Wall Opening:**  
6 1/2" x 5 x 3" min  
(165 x 127 x 76 mm)



**130**  
RECESSED SHELF – REAR MOUNT

**Overall Dimensions:**  
18" x 7" x 4"  
(457 x 178 x 102 mm)

**Wall Opening:**  
5 1/2" x 16 1/2"  
(141 x 419 mm)

# WHO WE ARE

ASI Group designs, engineers, and manufactures fully integrated washroom accessories, partitions, lockers, and visual display products from one source.

Our family of companies work together with one mission in mind—“To make our customers successful by providing value that exceeds price and an excellent service experience.”



1

**Port House**  
Architect: Zaha Hadid Architects  
ASI Alpaco™ Partitions



2

**U.S. Bank Stadium**  
Architect: HKS  
Washroom Accessories and  
Solid Plastic Partitions





**WE ARE LASER FOCUSED ON DELIVERING EXACTLY WHAT YOU NEED—  
WHERE AND WHEN YOU NEED IT.**

Operating units and offices in the USA, Canada, Australia, Europe, Middle East, China, and Mexico, along with sales in more than 50 countries.

Our broad scope helps meet the needs of healthcare, education, office, and retail buildings, as well as airports, stadiums, government offices, cultural centers, and hotel/restaurant operations.

**SALES IN OVER 50 COUNTRIES**

**385+** DOMESTIC AND INTERNATIONAL SALES REPRESENTATIVES

**1,000+** HIGHLY SKILLED EMPLOYEES

**>1.3** MILLION SQ. FT. MANUFACTURING & OFFICE FACILITIES



2



3



4

**3** **New York-Presbyterian David H. Koch Center**  
Architect: HOK Architects  
HDPE Plastic Z lockers, Phenolic Z lockers, Metal Z lockers, and Stainless Steel Accessories and Partitions



**4** **Perimeter College**  
Architect: Teeple Architects  
ASI Visual Display Products



**PAPER TOWEL DISPENSERS**

Model	Page
0210	36/52
0210-41	36/42/44/52
0215	37/56
0245-SS	37/56
0439	36/57
0452	36/53
0452-9	36/53
045210A	39/55
045210A-6	39/55
045210A-9	39/55
045210AC	39/55
045210A-6	39/55
045210A-9	39/55
0457	36/53
0457-2	53
0457-9	36/53
1002	37/56
1005	56
20210	27/52
20452	28/50/54
204523A	30/55
204523A-6	30/55
204523A-9	30/55
204523AC	30/55
204523A-6	30/55
204523A-9	30/55
6452	19/52
6452-9	19/52
645210A	11/20/54
645210A-6	20/54
645210A-9	20/54
645210A-00	11/54
645210A-41	11/54
645210AC	11/20/54
645210AC-6	20/54
645210AC-9	20/54
645210AC-00	11/53/54
645210AC-41	11/53/54
645224A	55
645224A-6	21/55
645224A-9	21/55
645224AC	21/55
645224AC-6	21/55
645224AC-9	21/55
6457	10/19/52
6457-00	53
6457-41	53
68523A	21/54
68523A-4	21/54
68523AC	21/54
68523AC-4	21/54
8165	40/57
8370	57
8374	57
8522	40/57

8523A	38/40/55/57
8523AC	38/40/55/57
8523A	38/40/55/57
8523AC	38/40/55/57
8524	55

**SOAP, FOAM, AND SANITIZER DISPENSERS**

Model	Page
0326	22/64
0332	63
0332-C	63
0332-CD	63
0332-D	63
0334-B	61
0334-S	61
0335-B	61
0335-S	61
0336	63
0338	63
0339	63
0341	64
0345	45/65
0345-41	45/65
0347	45/65
0347-41	45/65
0357	65
0359	65
0360	62
0361	62
0362	62
0362-41	45/58/62
0387	59/61
0390	59
0390-(N)	59/60
0391-(N)	60
0391-(N)-41	60
0391-1A	60
0391-1AC	60
0391-6-1A	60
0391-6-1AC	60
0393-(N)	60
0394-(N)	60
0397	59/62
0397-1A	60
0397-1A-41	60
0397-1AC	60
0397-1AC-41	46/59/60
0502	143
20334	62
20363	27/62
20364	27/62
20365	27/62
5001-SS	64
9343	27/64
9343-41	27/46/64

**WASTE RECEPTACLES**

Model	Page
0458	41/69
0458-9	41/69
04733	41/71
0815	68/148
0825	40/70
0826	40/70
0827	40/70
0828	40/70
0829	41/69
0834	41/68
0834-RB	68
0834-T	41/68
0839	41/68
0839-RB	68
0839-T	41/68
1000	41/68
1000A	41/68
1003	40/68
20458	28/70
20826	27/69
20826-T	27/69
6474	20/66/71
6474-41PC	20/46/71
6474-2	20/71
6474-2-41PC	20/46/71
6474-00	10/71
6459	19/71
7317	69/138
7317-S	69/138

**AUTOMATIC HAND DRYERS**

Model	Page
0135-1	23/75
0135-2	23/75
0184	75
0185	75
0185-00	75
0185-92	75
0185-93	75
0192-1-93	74
0192-1-41	74
0192-2-93	74
0196-1-00	72/74
0196-1-41	46/72/74
0196-1-93	72/74
0196-2-00	74
0196-2-41	74
0196-2-93	74
0197-2-93	74
0198-MH	75/149/156
0199-1-00	74
0199-1-93	74
0199-1-41	46/74
0199-2-00	74
0199-2-41	74

0199-2-93	74
20199	31/75

**MIRRORS/CABINETS**

Model	Page
0535	79
0600	78/79
0600-41	46/79
0600-T	78/79
0605	78/79
0620	78/79
0625	78/79
0640	78/139
0641	78/139
0952	81/146
0952-B	81/146
0953	81/144/146
20650	31/78/79
20650-B	78/79
20655	31/78/79
8026	80
8287	80
8338	81/147
8339	81/147
8340	81/147

**BABY CHANGING STATIONS**

Model	Page
9012	84
9013	87
9013-9	87
9014	84
9014-41	47/84
9015	84
9017	86
9017-9	86
9018	87
9018-41	47/86
9018-9	87
9018-9-41	86
9020	85
9022	85
9024-41	85
9026-41	85

**SHELVES**

Model	Page
0412	91
0690	90
0692	90/91
0692-5xx	90/91
0692-6xx	90/91
0692-8xx	90/91
0694	90/91
0698	91
20692	31/88/90/91

**FEMININE HYGIENE VENDORS**

Model	Page
0464	94
0468	92/95
0468-2	95
04684	95
0864	94
204684	31/95
204684-9	31/95
6468	23/94
64684	23/94

**TOILET TISSUE DISPENSERS**

Model	Page
0030	98/105
0030-41	48/98
0031	98
0032	98
0039	99
0040	99
0042	99
0042-41	42/48/99
0046	99
0263-1	103
0263-1A	103
0264-1	103/104
0264-12	103
0264-1A	103
0264-1A2	103
0266	104
0267	104
048234	103/127
0697-GAL	102
0705-Z	102
0710	103
0715	103
20030	30/98
20031	30/98
7303-B	104
7303-S	104
7305-B	101
7305-S	101
7305-41	48/101
7305-2B	102
7305-2-41	48/102
7305-2S	102
7314	102/138
7314-H	102/139
7316	102/139
7402-BSM	100
7402-B	100
7402-HB	100
7402-HS	100
7402-SSM	100
7402-S	100
7402-HBSM	100
7402-HSSM	100
74022-BSM	101
74022-B	101

74022-HBSM	101
74022-HSSM	101
74022-HS	101
74022-SSM	101
74022-S	101
7403-B	101
7403-S	101
8010	103
8020	104
R-002	104
R-003	105
R-004	105
R-005	105
R-009	105

**TOILET SEAT  
COVER DISPENSERS**

Model	Page
0477	108
0477-SM	108
0477-SM-41	49/108
20477-SM	30/109
6477	23/106/109
6477-9	109

**HYGIENE  
DISPOSALS**

Model	Page
0472	112
0472-1	112
0473	112
0473-1	112
0473-A	112
0473-1A	110/112
0852	113
6471	23/113
20470	30/113
20852	30/113

**GRAB BARS**

Model	Page
3400/3500	115
3700/3800	115
3700-W	115
3800-W	115
3801-41	48/115
3801-18-41	48/115
3801-24-41	48/115
3801-36-41	48/115
3801-42-41	48/115
7801	115
7801-18	115
7801-24	115
7801-36	115
7801-42	115

**HOOKS**

Model	Page
0714	122
0719	123

0740-Z	123
0745-Z	123
0751	122
0751-A	122
7301-B	121
7301-S	121
1306	123/152
7308	118/120/138
7312	118/120/138
7340-41	49/120
7340-B	120
7340-S	120
7345-B	121
7345-S	121
7382-B	121
7382-S	121
8425	122

**TOILET TISSUE  
COMBINATION UNITS**

Model	Page
0481	127
0481-HC	127
04813	126
04813-HC	126
0482	126
0482-R	126
04822	127
04823	126
048234	103/127
04833	126
0483	126
0484	127
0484-HC	127
0484-HCR	127
0484-R	127
0485	127
0486	127
0487-R	124/126
0487-L	126
0487-R-9	126
0487-L-9	126

**SHOWER/TUB  
ACCESSORIES**

Model	Page
0010	132
0398	130
0399	130
0400	130
0401	130
0720-Z	131
0721-Z	131
0735-Z	131
0755-SS	135
0755-Z	135
0760-Z	134
1200-SHU	130/132

1200-V	130/132
1201-A	130
1201-B	130
1201-41	130
1204-1	130
1204-2	130
1204-C	130
1214	130
1224	130
1224-C	130
7306	134/141
7307-18	135/141
7307-24	135/141
7311-B	135
7320	131
7320-B	131
7320-S	131
7335	131
7335-B	131
7335-S	131
7355	135
7355-24-41	49/135
7355-B	135
7355-S	135
7360-B	134
7360-S	134
7380-B	134
7380-S	134
7385-41	49/134
7385-B	134
7385-S	134
7404-B	130
7404-S	130
7410-B	130
7410-S	130
8202	133
8203	132
8204	132
8205-R	133
8205-L	133
8206-R	133
8206-L	133
8206-SC-R	133
8206-SC-L	133
8207	132
8208-R	132
8208-L	132
8209	133
8358	132

**HOSPITALITY  
ACCESSORIES**

Model	Page
0002-SM	143
0258-SS	142
0259-SS	142
0259-B	141
0502	65/143

0640	78/139
0640-2436	139
0640-3036	139
0640-4836	139
0640-6036	139
0641	78/139
0641-2436	139
0641-3036	139
0641-4836	139
0641-6036	139
0711-B	143
0712	140
0785-Z	141
1201-A	128/130/142
1201-B	130/142
1201-41	142
7306	134/141
7307-18	135/141
7307-24	135/141
7308	118/120/138
7312	118/120/138
7314	102/138
7314-H	102/139
7316	103/139
7317	69/138
7317-S	69/138
7322	141
7355-24-41	19/135
7381	140
7383	140
7387	140
8091	143

**HEALTHCARE  
ACCESSORIES**

Model	Page
0198-MH	75/149/156
0349	147
0350	147
0501-X	149
0501-1	149
0501-2	149
0501-3	149
0501-4	144/149
0511	149
0512	149
0515	147
0533 SERIES	144/146/153
0533-1	146/153
0533-2	146/153
0533-3	146/153
0533-4	146/153
0548	148
0548-9	148
0551	148
0556	149
0557	149
0558-1	149
0559	149
0815	68/148
0952	81/146
0952-B	81/146
0953	81/144/146
8154	146

8155	146
8156	146
8338	81/147
8339	81/147
8340	81/147

**CUSTODIAL  
ACCESSORIES**

Model	Page
0533 SERIES	146/149/153
0533-1	146/153
0533-2	146/153
0533-3	146/153
0533-4	146/153
1306	123/152
1307-3	150/152
1307-4	152
1307-5	152
1307-6	152
1308-3	152
1308-4	152
1315-4	153
1315-3	153
1315-6	153
8215-3	153
8215-4	153
8215-5	153

**SECURITY  
ACCESSORIES**

Model	Page
0198-MH	75/149/156
101-14	157
105-14	157
110-1	156
110-13	156
120	156
123	156
127	157
128-1	156
129	157
130	157
140	157
159	156
162	156
164	156
165	156
167	156
169	156

# INDEX OF PRODUCTS BY MODEL NUMBER

MODEL	PAGE	MODEL	PAGE	MODEL	PAGE	MODEL	PAGE	MODEL	PAGE
0002-SM	143	0341	64	0397-1A	59/60	0473	112	0640-6036	139
0010	132	0345	45/65	0397-1AC	58/59	0473-1	112	0641	78/139
0030	98/105	0345-41	45/65	0397-1A-41	59/60	0473-A	112	0641-2436	139
0030-41	48/98	0347	45/65	0397-1AC-41	46/59/60	0473-1A	110/112	0641-3036	139
0031	98	0347-41	45/65	0398	130	04733	41/71	0641-4836	139
0032	98	0349	147	0399	130	0477	108	0641-6036	139
0039	99	0350	147	0400	130	0477-SM	108	0661-1	14
0040	99	0357	65	0401	130	0477-SM-41	49/108	0661-2	14
0042	99	0359	65	0412	91	0481	127	0661-T	12/14
0042-41	42/48/99	0360	62	0439	36/57	0481-HC	127	0661-FM-14	14
0046	99	0361	62	0452	36/53	04813	126	0661-FM-23	14
0135-1	23/75	0362	62	0452-9	36/53	04813-HC	126	0663-1	15
0135-2	23/75	0362-41	45/58/62	045210A	39/55	0482	126	0663-2	15
0184	75	0387	59/61	045210A-6	39/55	0482-R	126	0663-T	15
0185	75	0388	59	045210A-9	39/55	04822	127	0690	90
0185-00	75	0388-1A	59	045210AC	39/55	04823	126	0692	90/91
0185-92	75	0388-1AC	59	045210AC-6	39/55	048234	103/127	0692-5xx	90/91
0185-93	75	0389	59	045210AC-9	39/55	0483	126	0692-6xx	90/91
0192-1-93	74	0389-1A	59	0457	36/53	04833	126	0692-8xx	90/91
0192-1-41	74	0389-1AC	58/59	0457-2	53	0484	127	0694	90/91
0192-2-93	74	0390-(N)	60	0457-9	36/53	0484-HC	127	0697-GAL	102
01961-1-00	72/74	0390	59	0458	41/69	0484-HCR	127	0698	91
0196-1-41	46/72/74	0390-1A	59	0458-9	41/69	0484-R	127	0705-Z	102
0196-1-93	72/74	0390-1A-41	59	0458-DX	41/69	0485	127	0710	103
0196-1-41	46/74	0390-1AC	59	0458-CX	41/69	0486	127	0711-B	143
0196-2-00	74	0390-1AC-41	59	0462-AD	34	0487-L	126	0712	140
0196-2-41	46/74	0390-6-1A	59	0462-AD-9	34	0487-L-9	126	0714	122
0196-2-93	74	0390-6-1A-41	59	0464	94	0487-R	124/126	0715	103
0197-2-93	74	0390-6-1AC	59	0467	35	0487-R-9	126	0719	123
0198-MH	75/149/156	0390-6-1AC-41	59	0467-2	35	0501-X	149	0720-Z	131
0199-1-00	74	0390-ARK	59	0467-9	35	0501-1	149	0721-Z	131
0199-1-41	46/74	0390-BR	59	0468	92/95	0501-2	149	0735-Z	131
0199-1-93	74	0390-R	59	0468-2	95	0501-3	149	0740-Z	123
0199-2-00	74	0390-(N)	60	04684	95	0501-4	144/149	0745-Z	123
0199-2-41	74	0391-(N)	60	0469	34	0502	143	0751	122
0199-2-93	74	0391-(N)-41	60	0469-2	34	0511	149	0751-A	122
0210	36/52	0391-1A	59/60	0469-9	34	0512	149	0755-SS	135
0210-41	36/42/44/52	0391-1A-41	59	0469-BL	34	0515	147	0755-Z	135
0215	37/56	0391-1AC	59/60	04692-6	38	0533-1	146/153	0760-Z	134
0245-SS	37/56	0391-1AC-41	59	04692-9	38	0533-2	146/153	0785-Z	141
0258-SS	142	0391-6-1A	59/60	04692-9	38	0533-3	146/153	0815	68/148
0259-SS	142	0391-6-1A-41	59	04692A	38	0533-4	146/153	0825	40/70
0259-B	141	0391-6-1AC	59/60	04692A-6	38	0533 SERIES	144/146/153	0826	40/70
0263	104	0391-6-1AC-41	59	04692A-9	38	0535	78/79	0827	40/70
0263-1	104	0393-(N)	60	04692AC	38	0537	78	0828	40/70
0263-1A	104	0393-1A	59	04692AC-6	38	0548	148	0829	41/69
0264	104	0393-1A-41	59	04692AC-9	38	0548-9	148	0834	41/68
0264-1	103/104	0393-1AC	59	046921	38	0551	148	0834-RB	68
0264-12	103	0393-1AC-41	59	046921-6	38	0556	149	0834-T	41/68
0264-1A	103	0393-6-1A	59	046921-9	38	0557	149	0839	41/68
0264-1A2	103	0393-6-1A-41	59	046921A	38	0558-1	149	0839-41	47
0266	104	0393-6-1AC	59	046921A-6	38	0559	149	0839-RB	68
0267	104	0393-6-1AC-41	59	046921A-9	38	0600	78/79	0839-T	41/68
0326	22/64	0393-R	59	046921AC	38	0600-T	78/79	0852	113
0332	63	0394-(N)	60	046921AC-6	38	0600-1836-41	46	0852-41	49
0332-C	63	0394-1A	59	046921AC-9	38	0600-2436-41	46	0864	94
0332-CD	63	0394-1A-41	59	046924	39	0600-2448-41	46	0864-41	47
0332-D	63	0394-1AC	58/59	046924-9	39	0600-41	46/79	0952	81/146
0334-B	61	0394-1AC-41	46/58/59	046926	39	0605	78/79	0952-B	81/146
0334-S	61	0394-6-1A	59	04697	35	0620	78/79	0953	81/144/146
0335-B	61	0394-6-1A-41	59	04697-4	35	0625	78/79	101-14	157
0335-S	61	0394-6-1AC	59	04697-9	35	0640	78/139	105-14	157
0336	63	0394-6-1AC-41	59	04697-BL	35	0640-2436	139	110-1	156
0338	63	0397	58/60	0472	112	0640-3036	139	110-13	156
0339	63	0397-41	59	0472-1	112	0640-4836	139	120	156

MODEL	PAGE	MODEL	PAGE	MODEL	PAGE	MODEL	PAGE	MODEL	PAGE
123	156	204692AC-6	29	64623-41	10	7311-B	135	8091	143
127	157	204692AC-9	29	64623-41PC	44/27	7312	118/120/138	8154	146
128-1	154/156	2046921A	29	64623-9-41PC	44/27	7314	102/138	8155	146
129	157	2046921A-6	29	6467	10/16/18	7314-H	102/139	8156	146
130	157	2046921A-9	29	6467-41PC	18/44	7316	102/139	8165	40/57
140	157	2046921AC	29	6467-9	18	7317	69/138	8202	133
159	156	2046921AC-6	29	6467-9-41PC	18/44	7317-S	69/138	8203	132
162	156	2046921AC-9	29	6467-00	10	7320	131	8204	132
164	156	20470	30/113	6467-41	10	7320-B	131	8205-L	133
165	156	20477-SM	30/109	64672	22	7320-S	131	8205-R	133
167	156	20650	31/78/79	64672-41PC	22/45	7322	141	8206-L	133
169	156	20650-B	78/79	64672-1	11/22	7335	131	8206-R	133
1000	41/68	20655	31/78/79	64672-1-00	11	7335-B	131	8206-SC-L	133
1000A	41/68	20655-1830	31	64672-1-41	11	7335-S	131	8206-SC-R	133
1001	37	20655-1836	31	64672-2	22	7340-B	120	8207	132
1002	37/56	20655-2436	31	64676	18	7340-S	120	8208-L	132
1003	40/68	20692	31/88/90/91	64676-2	18	7340-41	49/120	8208-R	132
1005	56	20826	27/69	64676-9	18	7345-B	121	8209	133
1200-SHU	130/132	20826-T	27/69	6468	23/94	7345-S	121	8215-3	153
1200-V	130/132	20852	30/113	64684	23/94	7355	135	8215-4	153
1201-A	128/130/142	3400 SERIES	115	646924A	21	7355-B	135	8215-5	153
1201-B	130/142	3500 SERIES	115	646924A-9	21	7355-S	135	8287	80
1201-41	130/142	3700 SERIES	115	646924AC	21	7355-24-41	49/135	8338	81/147
1204-1	130	3700-W	115	646924AC-9	21	7360-B	134	8339	81/147
1204-2	130	3800 SERIES	115	64696	22	7360-S	134	8340	81/147
1204-C	130	3800-W	115	64696-6	22	7380-B	134	8358	132
1214	130	3801-41	48/115	64696-9	22	7380-S	134	8370	57
1224	130	3801-18-41	48/115	64696A	11/20	7381	140	8374	57
1224-C	130	3801-24-41	48/115	64696A-6	20	7382-B	121	8425	122
1306	123/152	3801-36-41	48/115	64696A-9	20	7382-S	121	8522	40/57
1307-3	150/152	3801-42-41	48/115	64696A-00	11	7383	136/140	8523A	38/40/55/57
1307-4	152	3874	116	64696A-41	11	7385-B	134	8523AC	38/40/55/57
1307-5	152	3874-M2337	116	64696AC	11/20	7385-S	134	8524	55
1307-6	152	5001-SS	64	64696AC-6	20	7385-41	49/134	9012	84
1308-3	152	6452	19/52	64696AC-9	20	7387	140	9013	87
1308-4	152	6452-9	19/52	64696AC-00	11	7402-B	100	9013-9	87
1315-3	153	645210A	11/20/54	64696AC-41	11	7402-BSM	100	9014	82/84
1315-4	153	645210A-6	20/54	6471	23/113	7402-HB	100	9014-41	47/84
1315-6	153	645210A-9	20/54	6474	20/66/71	7402-HBSM	100	9015	84
20030	30/98	645210A-00	11	6474-00	10/71	7402-HS	100	9017	86
20031	30/98	645210A-41	11	6474-2	20/71	7402-HSSM	100	9017-9	86
20199	31/75	645210AC	11/20/54	6474-2-41PC	20/46/71	7402-S	100	9018	87
20210	27/52	645210AC-6	20/54	6474-41	10	7402-SSM	100	9018-41	47/86
20334	62	645210AC-9	20/54	6474-41PC	20/46/71	74022-B	101	9018-9	82/87
20363	27/62	645210AC-00	11/53/54	6477	23/106/109	74022-BSM	101	9018-9-41	86
20364	27/62	645210AC-41	11/53/54	6477-9	109	74022-H	96	9020	85
20365	27/62	645224-6	21/55	68523A	21/54	74022-HBSM	101	9022	85
20452	28/50/54	645224-9	21/55	68523A-4	21/54	74022-HS	101	9024-41	82/85
204523A	30/55	645224A	55	68523AC	21/54	74022-HSSM	101	9026-41	85
204523A-6	30/55	645224A-6	21/55	68523AC-4	21/54	74022-S	101	9343	27/64
204523A-9	30/55	645224AC	21/55	7301-B	121	74022-SSM	101	9343-41	27/42/46/64
204523AC	30/55	645224AC-6	21/55	7301-S	121	7403-B	101	R-002	104
204523AC-6	30/55	645224AC-9	21/55	7303-B	101	7403-S	101	R-003	105
204523AC-9	30/55	6457	10/19/52	7303-S	101	7404-B	130	R-004	105
20458	28/70	6457-00	10/53	7304-41	18	7404-S	130	R-005	105
204623	26	6457-41	10/53	7305-2B	102	7410-B	130	R-009	105
204623-9	26	6459	19/71	7305-2S	102	7410-S	130		
204684	31/95	6462	11/18	7305-B	101	7801 SERIES	114/115		
204684-9	31/95	6462-2	18	7305-S	101	7801-18	115		
20469	24/26/32	6462-9	18	7305-41	48/101	7801-24	115		
20469-9	26	6462-00	11	7305-2-41	48/102	7801-36	115		
204692A	29	6462-41	8/11	7306	134/141	7801-42	115		
204692A-6	29	64623	10/19	7307-18	135/141	8010	103		
204692A-9	29	64623-9	19	7307-24	135/141	8020	104		
204692AC	29	64623-00	10	7308	118/120/138	8026	78/80		



441 Saw Mill River Rd.  
Yonkers, NY 10701  
Phone: 914.476.9000  
Web: [americanspecialties.com](http://americanspecialties.com)

© 2026 American Specialties, Inc., an ASI Group Company